



BURNSIDE

[THE DIFFERENCE IS OUR PEOPLE]

Appendix T

Noise Impact Assessment Report



BURNSIDE

**Noise Impact Assessment Report for
Warden Avenue and Kennedy Road
between Major Mackenzie Drive East
to Elgin Mills Road East**

Regional Municipality of York



BURNSIDE

**Noise Impact Assessment Report for
Warden Avenue and Kennedy Road
between Major Mackenzie Drive East
to Elgin Mills Road East**

Regional Municipality of York

**R.J. Burnside & Associates Limited
6990 Creditview Road, Unit 2
Mississauga ON L5N 8R9 CANADA**

**February 2023
300052314.0000**

Noise Impact Assessment Report for
 Warden Avenue and Kennedy Road between Major Mackenzie Drive East to Elgin Mills Road East
 February 2023

Distribution List

No. of Hard Copies	PDF	Email	Organization Name
0	Yes	Yes	The Regional Municipality of York

Record of Revisions

Revision	Date	Description
0	August 25, 2022	Draft Report Submission to The Regional Municipality of York
1	February 6, 2023	Submission to the Regional Municipality of York

R.J. Burnside & Associates Limited

Report Prepared By:



Brent Miller, P.Eng.
 Air & Noise Engineer
 BM:lam

Report Reviewed By:

A handwritten signature in black ink, appearing to read "Kristina Zeromskiene".

Kristina Zeromskiene, PhD, LEL
 Sr. Air & Noise Scientist

Noise Impact Assessment Report for
Warden Avenue and Kennedy Road between Major Mackenzie Drive East to Elgin Mills Road East
February 2023

Executive Summary

R.J. Burnside & Associates Limited has been retained by the Regional Municipality of York to provide noise assessment services in support of the Class Environmental Assessment (EA) Studies for the proposed improvements to Warden Avenue and Kennedy Road from Major Mackenzie Drive to Elgin Mills Road. The Future Urban Area for the City of Markham (City). Warden Avenue and Kennedy Road are under the jurisdiction of the Regional Municipality of The Regional Municipality of York . The objective of the Noise Impact Assessment was to determine changes to the road traffic noise levels within the study areas due the road improvements and to determine whether any mitigation measures are required.

The traffic data relied upon was provided by York Region. This report presents the results of road traffic noise impact assessment conducted using STAMSON, the Ministry of the Environment, Conservation and Parks (MECP) road traffic noise calculation program. The assessment used four Points of Reception (POR) at the plane of window on the most exposed side of the dwelling. All four Points of Reception also had a corresponding Outdoor Living Area (OLA) location. Modelled noise levels were calculated for two scenarios: Start of Construction Year, Mature State of Development. The Mature State Build scenario represents conditions with the proposed roads improvements. The results of this assessment for each of the scenarios were compared to criteria in York Region's Traffic Noise Mitigation Policy (TNMP) (2006) (which is supported in the York Region Standard Operating Procedure for Noise (SOP)) to determine whether the potential increase or the magnitude of the noise levels due to the Mature State Build scenario would merit mitigation measures under the Regional procedure.

It was determined that no significant increases to traffic noise are expected as a result of the project. Therefore, the impact on the receptors will not increase because of the redesign of the road. The assessment found that the predicted noise levels do exceed the maximums set out in York's TNMP criteria. The traffic noise was assessed up to the mature state of development in the year 2041. The planned future road centerline is not proposed to change from the existing centerline.

Although exceedances above the TNMP criteria of 60 dBA were found for receptors along the Warden Avenue and Kennedy Road alignments, standard mitigation options of acoustic barriers at the property lines for the exceeding PORs are not recommended following the terms of the SOP.

Table of Contents

1.0	Introduction	7
2.0	Study Areas	8
3.0	Noise Assessment	9
3.1	Noise Impact Assessment Criteria	9
3.2	Sensitive Receptors	10
3.2.1	A property of a person that accommodates a building used for a noise sensitive institutional purpose - Warden Avenue Receptors	11
3.2.2	Kennedy Road Receptors	11
3.3	Noise Impact Assessment Methodology	12
3.4	Traffic Data	13
3.4.1	Warden Avenue Traffic Data	13
3.4.2	Kennedy Road Traffic Data	14
3.5	Elgin Mills Traffic Data	15
3.6	Result Interpretation	16
3.7	Warden Avenue Results	16
3.8	Kennedy Road Results	18
4.0	Conclusion	19
5.0	References	19

Tables

Table 1: Mitigation Effort Required for the Projected Noise Level with the Proposed Improvements above the Ambient

Table 2: Warden Avenue OLA Receptors

Table 3: Kennedy Road OLA Receptors

Table 4: Road Traffic Growth Rates

Table 5: STAMSON Warden Avenue Traffic Inputs for the Preferred Design Concept

Table 6: STAMSON Kennedy Road Traffic Inputs for the Preferred Design Concept

Table 7: Interpretation of Adjusted Impact Level.

Table 8: Warden Predicted Daytime Sound Levels for Start of Construction and Mature State Scenarios

Table 9: Kennedy Predicted Daytime Sound Levels for Start of Construction and Mature State Scenarios

Figures

Figure 1: Study Area – Warden Avenue

Figure 2: Study Area – Kennedy Road

Figure 3: Points of Reception – Warden Avenue

Figure 4: Points of Reception – Kennedy Road

Noise Impact Assessment Report for
Warden Avenue and Kennedy Road between Major Mackenzie Drive East to Elgin Mills Road East
February 2023

Appendices

Appendix A Traffic Data

Appendix B Sample Noise Calculations

Appendix C Municipal Noise Standards

Appendix D Noise Memorandum – Identification of Points of Reception

Noise Impact Assessment Report for
Warden Avenue and Kennedy Road between Major Mackenzie Drive East to Elgin Mills Road East
February 2023

Disclaimer

Other than by the addressee, copying or distribution of this document, in whole or in part, is not permitted without the express written consent of R.J. Burnside & Associates Limited.

In the preparation of the various instruments of service contained herein, R.J. Burnside & Associates Limited was required to use and rely upon various sources of information (including but not limited to: reports, data, drawings, observations) produced by parties other than R.J. Burnside & Associates Limited. For its part R.J. Burnside & Associates Limited has proceeded based on the belief that the third party/parties in question produced this documentation using accepted industry standards and best practices and that all information was therefore accurate, correct and free of errors at the time of consultation. As such, the comments, recommendations and materials presented in this instrument of service reflect our best judgment in light of the information available at the time of preparation. R.J. Burnside & Associates Limited, its employees, affiliates and subcontractors accept no liability for inaccuracies or errors in the instruments of service provided to the client, arising from deficiencies in the aforementioned third party materials and documents.

R.J. Burnside & Associates Limited makes no warranties, either express or implied, of merchantability and fitness of the documents and other instruments of service for any purpose other than that specified by the contract.

Noise Impact Assessment Report for
Warden Avenue and Kennedy Road between Major Mackenzie Drive East to Elgin Mills Road East
February 2023

Glossary of Terms and Acronyms

AADT	Annual Average Daily Traffic
Burnside	R.J. Burnside & Associates Limited
EA	Environmental Assessment
MECP	Ministry of the Environment, Conservation and Parks
MTO	Ontario Ministry of Transportation
Noise Guide	Ontario Ministry of Transportation Environmental Guide for Noise, October 2006
NSA	Noise Sensitive Area
OLA	Outdoor Living Area
ORNAMENT	Ontario Road Noise Analysis Method
POR	Point of Reception
POW	Plane of Window
STAMSON	MECP Transportation Noise Modeling Software
vpd	vehicles per day
City	Markham
Region	The Regional Municipality of York

Noise Impact Assessment Report for
Warden Avenue and Kennedy Road between Major Mackenzie Drive East to Elgin Mills Road East
February 2023

1.0 Introduction

R.J. Burnside & Associates Limited has been retained by the Regional Municipality of York to provide noise assessment services in support of the Class Environmental Assessment (EA) Studies for the proposed improvements to Warden Avenue and Kennedy Road from Major Mackenzie Drive to Elgin Mills Road. The extents of Warden Avenue and Kennedy Road being considered are located in the Future Urban Area for the City of Markham (City). Warden Avenue and Kennedy Road are under the jurisdiction of the Regional Municipality of York. The objective of the Noise Impact Assessment was to determine changes to the noise levels within the study areas due the road improvements and to determine whether any mitigation measures are required.

The EA is being completed in accordance with the requirements of a Municipal Class EA, Schedule C undertaking as outlined in the Municipal Engineers Association Municipal Class Environmental Assessment Document (October 2000, as amended 2007, 2011 & 2015), which is an approved process under the *Ontario Environmental Assessment Act*.

York Region has a Traffic Noise Mitigation Policy (TNMP) which is the standard used for this study. The Standard Operating Procedures (SOP) for Traffic Noise Mitigation on Regional Roads from York Region (November 2019) is another regulation document guiding this study.

The primary document guiding this study is the Technical Memorandum Noise Impact Assessment (Noise Memorandum) prepared by Burnside, which was submitted to and approved by York Region. The Noise Memorandum proposes changes to the approach to noise assessments from the TNMP and SOP. These proposals were discussed with York Region. York Region had input and final approval of this Noise Memorandum. Therefore, the Noise Memo requirements supersede the TNMP and SOP for this project. This Noise Memorandum is provided in Appendix D.

The Noise Impact Assessment investigates the following scenarios:

1. Current Conditions – named “Construction Year” under the SOP, and “Start of Construction Year” in the Noise Memorandum.
2. Mature State of Development – named “Mature State Build” or “Mature State No Build” in this report.

The Schedule C Noise Environmental Assessment has been completed for the preferred design concepts identified for the redevelopment of Warden Avenue and Kennedy Road in the study areas.

Noise Impact Assessment Report for
Warden Avenue and Kennedy Road between Major Mackenzie Drive East to Elgin Mills Road East
February 2023

2.0 Study Areas

As per the Ontario Ministry of Transportation (MTO) Environmental Guide for Noise (Noise Guide) (MTO, 2006), the Study Areas for the Noise Impact Assessments for Warden Avenue and Kennedy Road has been determined by calculating the setback distance from either Warden Avenue or Kennedy Road to the point where there is no predicted increase in noise impacts from Warden Avenue or Kennedy Road above the MECP's objective sound level for Outdoor Living Areas (OLAs). For both roads this distance was calculated to be 150 metres. Documentation for this calculation has been provided in Appendix B.

The Study Areas for Warden Avenue and Kennedy Road are illustrated in Figure 1 and Figure 2 respectively.

Noise Impact Assessment Report for
Warden Avenue and Kennedy Road between Major Mackenzie Drive East to Elgin Mills Road East
February 2023

3.0 Noise Assessment

3.1 Noise Impact Assessment Criteria

Warden Avenue and Kennedy Road are regional roads under the jurisdiction of the Regional Municipality of The Regional Municipality of York .

York Region has a standard operating procedure (SOP) for capital program projects. The SOP defines how noise mitigation and evaluation shall be conducted for regional road reconstruction projects.

Table 1: Mitigation Effort Required for the Projected Noise Level with the Proposed Improvements above the Ambient

Change in Noise Level Above Ambient/Projected Noise Levels with Proposed Improvements	Mitigation Effort Required	Mitigation Effort Required	Mitigation Effort Required
	MTO Noise Guide		Burnside's Noise Memorandum
< 5 dBA ¹ change AND < 65 dBA	None	None	None
≥ 5 dBA change OR ≥ 60 dBA and < 65 dBA	None	Noise Control measures are to be designed for a future traffic level of Leq 16-hr of 60 dBA at the OLA. Barriers required by other provisions are required to be a minimum height of 2.2 m to a maximum height of 3.0 m. Barriers to provide a minimum of 6 dB reduction.	Investigate noise control measures at 4 receptors along Right-of-Way. Assess extra neighboring receptors if an exceedance is found. Follow Appendix A of the York Region SOP to determine if any controls are administratively feasible.

¹dBA (A-weighted decibel) is an expression of the relative loudness of sounds in air as perceived by the human ear.

Noise Impact Assessment Report for
Warden Avenue and Kennedy Road between Major Mackenzie Drive East to Elgin Mills Road East
February 2023

Change in Noise Level Above Ambient/Projected Noise Levels with Proposed Improvements	Mitigation Effort Required	Mitigation Effort Required	Mitigation Effort Required
	MTO Noise Guide	York Region TNMP & York Region SOP	Burnside's Noise Memorandum
≥ 5 dBA change OR ≥ 65 dBA	Investigate noise control measures on Right-of-Way. Introduce noise control measures within Right-of-Way and mitigate to ambient if technically, economically, and administratively feasible. Noise control measures, where introduced, should achieve a minimum of 5 dBA attenuation, over first row receivers.	No additional requirements.	No additional requirements.

All candidate site for mitigation must a residential development sharing a property line with a Regional Road allowance, having existing reverse frontage or flanking homes as described in Standard Operation Procedures Supplement Document: Case Scenario Guideline - Noise Sensitive Uses

3.2 Sensitive Receptors

A Noise Sensitive Area (NSA) is defined in the SOP as a group of one or more properties that are a noise sensitive land use. An NSA groups all sensitive receptors in an area that are exposed to similar noise influences. The Outdoor Living Area (OLA) assessed for each NSA is the most exposed receptor in the NSA. For OLAs the location taken is 3 m off the centre of the façade best interpreted as the start of the OLA area such as a backyard.

The developer of any future subdivision within the study area will be responsible for the noise mitigation. This is in keeping with the Regional Policies, SOP and Provincial guidelines and common practices. York Region's Site Plan Application process should

Noise Impact Assessment Report for
Warden Avenue and Kennedy Road between Major Mackenzie Drive East to Elgin Mills Road East
February 2023

ensure that this takes place, with the appropriate traffic noise analysis considering the future expansions of these roadways.

Noise sensitive land use, as described by the Ministry of the Environment, Conservation and Parks (MECP, 2013), means:

- A property of a person that accommodates a dwelling and includes a legal nonconforming residential use.
- A property of a person that accommodates a building used for a noise sensitive commercial purpose.
- A property of a person that accommodates a building used for a noise sensitive institutional purpose.

3.2.1 Warden Avenue Receptors

Based on aerial imagery there are eleven residential properties near Warden Avenue that are noise sensitive land uses. These eleven NSAs are conservatively represented by two receptors. However, assessment of these locations required assessment of the neighbouring receptors as per the agreement in the Noise Memorandum. Therefore, four receptors have been assessed. All receptors are assessed at the OLA. Table 2 below provides relevant assumptions and observations about each OLA.

Table 2: Warden Avenue OLA Receptors

Receptor	Location Relative to Dwelling	SOP Barrier Case
OLA03	West	Ineligible – Case C01 Frontage property
OLA12	West	Ineligible – Case C01 Frontage property
OLA16	South	Eligible – single dwelling siding onto road
OLA17	West	Ineligible – Case C01 Frontage property

We note that OLA16 has an existing fence. An inspection by Burnside early 2022 determined it was not an acoustic barrier quality fence. Therefore, it was not included in the assessment.

Figure 3 illustrates all sensitive receptors for all the NSAs within the Warden Avenue Study Area. The selection of receptors is further justified in the Noise Memorandum provided to York Region in advance of this study, which is included in Appendix D.

3.2.2 Kennedy Road Receptors

Based on aerial imagery there are twelve residential properties near Kennedy Road that are noise sensitive land uses. There is also one area of institutional land use which is considered noise sensitive, the Angus Glen Montessori School. These thirteen NSAs are conservatively represented by two receptors, both of which are assessed at the OLA.

Noise Impact Assessment Report for
Warden Avenue and Kennedy Road between Major Mackenzie Drive East to Elgin Mills Road East
February 2023

Table 3: Kennedy Road OLA Receptors

Receptor	Location Relative to Dwelling	SOP Barrier Case
OLA06	North	Eligible – single dwelling siding onto road
OLA08	West	Ineligible – Case C01 Frontage property

3.3 Noise Impact Assessment Methodology

To determine the potential noise impact, future the proposed road improvements were compared were predicted using traffic noise prediction method Noise Analysis Method for Environment and Transportation STAMSON (version 5.04) computer program as SOP.

The sound levels were predicted based on the Annual Average Daily Traffic (AADT) value as required by the SOP for scenarios: Start of Construction Year, and Mature State of Development. The future scenario is based on forecasted traffic (to 2041).

The following are specific requirements from the SOP which are applicable to this project.

- Traffic noise shall be calculated at the “Start of Construction” and “Mature State of Development” years.
- The following traffic data shall be provided:
 - Volume of vehicles moving on an hourly basis (two-directional).
 - Traffic Day/Night Split (percentage of all vehicles moving during the period from 7 a.m. to 11 p.m. and other volume moving from 11 p.m. to 7 a.m.).
 - Speed statistics (50th percentile, 85th percentile and volume weighted speed)
 - Traffic mix (percentage of vehicles, automobiles, medium trucks, and heavy trucks).
 - Traffic information should be collected for minimum three full days during the weekdays (Tuesday, Wednesday, Thursday).²

² Burnside used the traffic count data provided by the Region for this assessment. During the COVID-19 pandemic, the Region was not able to capture 3 full days of traffic count data. The traffic increases are based on the future approved development in the Study Area and are not anticipated to result in any substantial difference in the noise impact analysis provided.

Noise Impact Assessment Report for
Warden Avenue and Kennedy Road between Major Mackenzie Drive East to Elgin Mills Road East
February 2023

- Road sections not shown in the Region's Road Construction Program provisions should be made to update the study where future construction commitments may be made by the Region.
- A maximum of five lots or dwellings can be represented by one receptor where a barrier calculation is performed.
- All receptors that have an outdoor noise sensitive land use component are to be identified and addressed in the study.
- The higher of the posted speed limit and the actual driving speed (85th percentile) shall be used in the calculation of sound levels.
- Where truck percentages exceed 5% and where sound barriers are warranted, additional supplementary analysis of each vehicle class shall be conducted and then combined to show the total of all vehicle categories.
- Retrofit barriers are to be determined through the MTO Noise Guide procedure. According to the MTO Noise Guide, where an increase in sound level is predicted, mitigation measures may be required as summarized in Table 1. Additional modifications from the SOP of York Region are included.

3.4 Traffic Data

Traffic data for this report was obtained from York Region. Growth rates were obtained from the Burnside team preparing the Transportation Study. Unique growth rates were applied to each decade. The growth rates used in this study are provided in the tables below.

Table 4: Road Traffic Growth Rates

Road	Annual Growth Rate (Present to 2031)	Annual Growth Rate (2032 to 2041)
Major Mackenzie Drive East	0.5%	0.5%
Elgin Mills Road East	7%	0.5%
Warden Avenue	3%	2.0%
Kennedy Road	3%	2.0%

3.4.1 Warden Avenue Traffic Data

All traffic data information has come from the Burnside group preparing the traffic analysis for this EA Study. Traffic counts for 2021 indicate an AADT of 12,427 vehicles per day (vpd) between Major Mackenzie Drive East and Elgin Mills Road East.

To determine the 2027 (Construction Year²) AADT levels a growth rate of 3% was assumed and applied for 6 years, which results in an AADT of 14,271 vpd. It is assumed that the proposed upgrades to Warden Avenue and Kennedy Road will not impact the future traffic levels. Growth rates, as per Table 5, were applied until 2041 to

Noise Impact Assessment Report for
Warden Avenue and Kennedy Road between Major Mackenzie Drive East to Elgin Mills Road East
February 2023

get the mature state of development AADT. Therefore, the following AADT levels are used for this study:

- Existing Year AADT (2021): 13,410 vpd
- Start of Construction Year AADT (2027³): 14,271 vpd
- Mature State of Development AADT (2041): 20,359 vpd

York Region reports that the medium truck percentage is 2%, whereas the heavy truck percentage use is 3%. A 90/10 day night split was assumed as the actual information was not available.

Relevant excerpts of the raw traffic data are provided in Appendix A. Table 5 provides traffic inputs for the preferred Design Concept.

Table 5: STAMSON Warden Avenue Traffic Inputs for the Preferred Design Concept

Scenario	AADT ^[3]	Day Night Split ^[2]	85 th percentile Speed (kph)	50 th percentile Speed (kph)	% of Medium Trucks ^[1]	% of Heavy Trucks ^[1]
Warden Study Area: POR03 & POR16, OLA03 & OLA16						
Present (2021)	13,410		86	77	2 %	3 %
Start of Construction Year (2027)	14,271	90 / 10	86	77	2 %	3 %
Mature State of Development (2041)	20,359	90 / 10	86	77	2 %	3 %
<p>[1] As per traffic analysis.</p> <p>[2] The day-night traffic volume was split 90/10 as per STAMSON Technical Document recommendation.</p> <p>[3] As per traffic data in Appendix A.</p> <p>*2% road gradient was assumed for all calculations.</p>						

3.4.2 Kennedy Road Traffic Data

York Region Traffic counts for 2021 indicate an AADT of 7,910 vehicles per day (vpd) between Major Mackenzie Drive East and Elgin Mills Road East.

To determine the 2028 (Start of Construction Year) AADT levels a growth rate of 3% was assumed and applied for 7 years, which results in an AADT of 9,265 vpd. A 90/10 day night split was assumed as the actual information was not available. It is assumed that the proposed upgrades to Warden Avenue and Kennedy Road will not impact the future traffic levels. Growth rates, as per Table 5, were applied until 2041 to get the

³ As per the 10-year York Region Capital Projects plan (included in Appendix A)

Noise Impact Assessment Report for
Warden Avenue and Kennedy Road between Major Mackenzie Drive East to Elgin Mills Road East
February 2023

mature state of development AADT. Therefore, the following AADT levels are used for this study:

- Present Year AADT (2021): 7,910 vpd
- Start of Construction Year AADT (2028⁴): 9,265vpd
- Mature State of Development AADT (2041): 12,958vpd

York Region reports that the medium truck percentage is 1.2%, whereas the heavy truck percentage use is 1.8%.

Relevant excerpts of the raw traffic data are provided in Appendix A.

Table 6: STAMSON Kennedy Road Traffic Inputs for the Preferred Design Concept

Scenario	AADT ^[1]	Day Night Split ^[2]	85 th percentile Speed (kph)	50 th percentile Speed (kph)	% of Medium Trucks ^[1]	% of Heavy Trucks ^[1]
Kennedy Study Area: POR06 & POR08, OLA06 & OLA08						
Present	7,910	90 / 10	94	84	1.2 %	1.8 %
Start of Construction Year	9,265	90 / 10	94	84	1.2 %	1.8 %
Mature State of Development	12,958	90 / 10	94	84	1.2 %	1.8 %
[1] As per traffic analysis.						
[2] The day-night traffic volume was split 90/10 as per STAMSON Technical Document recommendation.						
*2% road gradient was assumed for all calculations.						

3.5 Elgin Mills Traffic Data

Elgin Mills Road traffic data was also provided by York Region and does impact the noise levels at certain receptors. The 2021 AADT is 11,050 vpd with a total 1.4% medium truck and 0.6% heavy truck composition. The 2041 AADT is 22,849 vpd with a total 1.4% medium truck and 0.6% heavy truck composition. A 90/10 day night split was assumed as the actual information was not available. Relevant excerpts of the raw traffic data are provided in Appendix A. A speed profile was not available for Elgin Mills Road. Therefore, the posted speed limit of 80 km/h was used instead of the 85th percentile speed data.

⁴ As per the 10-year York Region Capital Projects plan (included in Appendix A)

3.6 Result Interpretation

The MECP provides the Table 7 of impacts and how they should be interpreted:

Table 7: Interpretation of Adjusted Impact Level.

Adjusted Impact Level	Impact Rating
0-2.99 decibel (dB)	Insignificant
3-4.99 dB	Noticeable
5-9.99 dB	Significant
10+dB	Very Significant

The comparison is typically done, as per the MTO criteria, between the future build and no build conditions. The Noise Memorandum, provided in Appendix D, has limited the scope of this Noise Impact Study to only the Start of Construction Year, and the future Mature State of Development conditions. This interpretation of adjusted impact level is therefore not applicable, as it is only used to differentiate between two future conditions and only one is being assessed. However, it is worth noting that without a change in the alignment of the road there would be no difference in the calculations performed for the future conditions of build and no-build.

The predicted sound levels before and after the road improvements (road widening) are summarized in Table 8 and sample noise modelling printouts can be found in Appendix B. All sound levels are predicted for the daytime as the MTO criteria is designed for OLAs, which are not expected to be used during the nighttime hour. As all roads in this assessment have been estimated to have a 90/10 daytime-nighttime traffic split, the nighttime impacts at all receptors will be significantly lower than the reported daytime results.

3.7 Warden Avenue Results

Table 8: Warden Predicted Daytime Sound Levels for Start of Construction and Mature State Scenarios

POR ID - Location	Start of Construction Year Sound Levels (2027)	Mature State of Development Sound Levels (2041)
	Leq (16hr) (dBA)	Leq (16hr) (dBA)
POR03 – 10506 Warden Avenue	63	65
OLA03 – 10506 Warden Avenue	62	63
POR12 – 10508 Warden Avenue	63	65
OLA12 – 10508 Warden Avenue	61	63
POR16 – 3 Heritage Hill Drive	63	65
OLA16 – 3 Heritage Hill Drive	62	63
POR17 – 10084 Warden Avenue	61	62
OLA17 – 10084 Warden Avenue	50	52

Noise Impact Assessment Report for
Warden Avenue and Kennedy Road between Major Mackenzie Drive East to Elgin Mills Road East
February 2023

In Table 8, the difference between the sound levels for “Start of Construction Year” and “Mature State of Development” scenarios are all caused by the increase in traffic due to population growth. All results are rounded to the nearest dB. It is a standard practice in the acoustic engineering field that calculated sound levels rounded to the nearest whole number when reported.

For all of the PORs and OLAs, there are no acoustically significant shifts in the road centerline alignment proposed for the future build case.

The OLAs do exceed the SOP design maximum of 60 dBA both presently and in the future. The exceedance at POR/OLA03 triggered the addition of POR/OLA12, as per the agreement in the Noise Memorandum of Appendix D. Similarly, the POR/OLA16’s exceedance triggered POR/OLA17’s inclusion in the assessment.

However, none of the points of reception meet the qualifications for retrofit noise barriers under the SOP. Note that the term retrofit barriers includes both replacing existing barriers with improved barrier and adding new barriers where none existed previously. Specifically, there is no location with 5 or more homes backing onto Warden Avenue, which could be protected by 1 barrier. Although OLA03 and OLA12 both exceed, they are rural properties more than 100 meters away from the next nearest OLA. A feasible barrier could not be constructed in this location. The exceedance at OLA16 does not exist at neighbouring OLA17 where the OLA is located further from the road and with the shielding from the dwelling. The whole study area contains similar such cases. No mitigation can be reasonably provided in any of these cases as the barriers would be long, expensive, and not protect the minimum number of dwellings as required under the SOP.

Therefore, the Warden Avenue Study Area does not need any further assessment and no mitigation is required for the future build case.

It should be noted that the calculations methods of York’s SOP do not allow for consideration of a few factors, which could increase the experienced sound levels at the PORs. Such factors include increase in true driving speed from the better road quality or decrease of congestion. These factors are not and cannot be captured by the modeling.

3.8 Kennedy Road Results

Table 9: Kennedy Predicted Daytime Sound Levels for Start of Construction and Mature State Scenarios

POR ID - Location	Start of Construction Year Sound Levels (2028)	Mature State of Development Sound Levels (2041)
	Leq (16hr) (dBA)	Leq (16hr) (dBA)
POR06 – 4510 Elgin Mills Road East	69	71
OLA06 – 4510 Elgin Mills Road East	66	66
POR08 – 10476 Kennedy Road	63	64
OLA08 – 10476 Kennedy Road	60	62
POR19 – 10476 Kennedy Road	62	64
OLA19 – 10476 Kennedy Road	55	56

Note that the speed profile for Elgin Mills Road East was not available and therefore the speed limit of the road (80 km/h) has been used instead of the 85th percentile speed. This only affects POR06 and OLA06. Elgin Mills is under the jurisdiction of York Region.

In Table 7, the difference between the sound levels for “Construction Year” and “Mature State No Build Scenario” are all caused by the increase in traffic due to population growth. All results are rounded to the nearest dB. It is a standard practice in the acoustic engineering field that calculated sound levels rounded to the nearest whole number when reported.

For all of the PORs and OLAs, there are no acoustically significant shifts in the road centerline alignment proposed for the future build case.

The OLAs do exceed the SOP design maximum of 60 dBA both presently and in the future. The exceedance at POR/OLA06, could not trigger the inclusion of another point of reception as there is no candidate receptor for which a contiguous barrier could exist, within the project scope. POR/OLA08’s exceedance triggered POR/OLA19’s inclusion in the assessment.

However, none of the points of reception meet the qualifications for retrofit noise barriers under the SOP. Specifically, there is no location with 5 or more homes backing onto Kennedy Road which could be protected by 1 barrier. Furthermore, due to OLA19’s location behind the dwelling, the calculated sound level was under 60 dBA which ended the extended assessment of OLA08’s exceedance.

Therefore, the Kennedy Road Study Area does not need any further assessment and no mitigation is required for the future build case.

Noise Impact Assessment Report for
Warden Avenue and Kennedy Road between Major Mackenzie Drive East to Elgin Mills Road East
February 2023

4.0 Conclusion

Although York Region's SOP maximum level for OLA's of 60 dBA is exceeded at several receptors, no receptors met the qualifications under the SOP for consideration for a retrofit barrier. Most of the dwellings along the alignment are farm style homes with OLAs located far apart from the neighbouring properties.

5.0 References

Ministry of the Environment (MOE). Computer Program STAMSON Version 5.04.

Ministry of Transportation (MTO). Environmental Guide for Noise. October 2006.

Ministry of the Environment (MOE). Environmental Noise Guideline. Stationary and Transportation Sources – Approval and Planning. Publication NPC-300., August 2013.

Ministry of the Environment (MOE). ORNAMENT – Ontario Road Noise Analysis Method for Environment and Transportation. Technical Document., October 1989.

Standard Operating Procedures (SOP's) for Traffic Noise Mitigation on Regional Roads, York Region, November 2019.

York Region Traffic Noise Mitigation Policy for Regional Roads, York Region, March 2006.



BURNSIDE

[THE DIFFERENCE IS OUR PEOPLE]



Figures

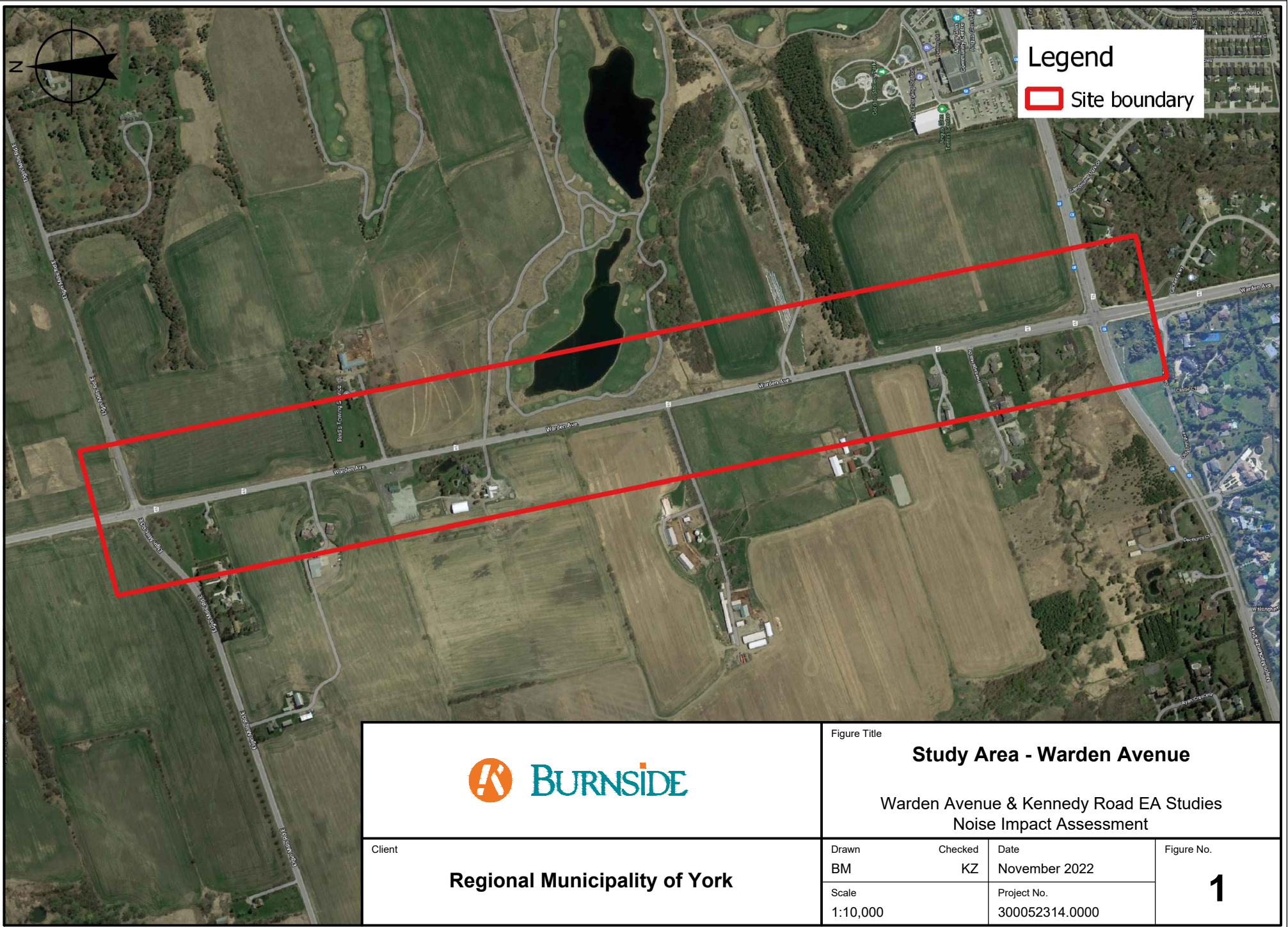

Legend
 Site boundary



Figure Title
Study Area - Warden Avenue
 Warden Avenue & Kennedy Road EA Studies
 Noise Impact Assessment

Client
Regional Municipality of York

Drawn BM	Checked KZ	Date November 2022	Figure No. 1
Scale 1:10,000	Project No. 300052314.0000		



Legend

Site boundary



Figure Title

Study Area - Kennedy Road

Warden Avenue & Kennedy Road EA Studies
Noise Impact Assessment

Client

Regional Municipality of York

Drawn	Checked	Date	Figure No.
BM	KZ	August 2022	
Scale	Project No.		2
1:10,000	300052314.0000		



Legend

- Site boundary
- Sensitive Receptors

		<p>Figure Title</p> <p>Points of Reception - Warden Avenue</p> <p>Warden Avenue & Kennedy Road EA Studies Noise Impact Assessment</p>		
<p>Client</p> <p>Regional Municipality of York</p>	<p>Drawn</p> <p>BM</p>	<p>Checked</p> <p>KZ</p>	<p>Date</p> <p>August 2022</p>	<p>Figure No.</p> <p>3</p>
	<p>Scale</p> <p>1:10,000</p>		<p>Project No.</p> <p>300052314.0000</p>	



Legend

- Site boundary
- Sensitive Receptors



Figure Title
Points of Reception - Kennedy Road
 Warden Avenue & Kennedy Road EA Studies
 Noise Impact Assessment

Client
Regional Municipality of York

Drawn BM	Checked KZ	Date August 2022	Figure No. 4
Scale 1:10,000	Project No. 300052314.0000		



BURNSIDE

[THE DIFFERENCE IS OUR PEOPLE]

Appendix A

Traffic Data

Appendix A



AADT Midblocks Report

Description	2010	2012	2014	2015	2017	2019
Kennedy Road btwn Major Mackenzie Drive East & Elgin Mills Road East	6913	6907	7318	7283	7910	6972



AADT Midblocks Report

Description	2010	2012	2014	2016	2018
Warden Avenue btwn Major Mackenzie Drive East & Heritage Hill Drive	6869	6928	7339	11811	11481

2021 10-Year Roads and Transit Capital Construction Program

Approved by Council on 25 March 2021

Road Project	Year
	Under Construction
	2021
	2022
	2023
	2024
	2025
	2026
	2027
	2028
	2029
	2030

Other Project	Type
	Bridge Replacement/Improvement
	Interchange/Intersection Improvement

VivaNext Projects	Status
	Future Subway Extension

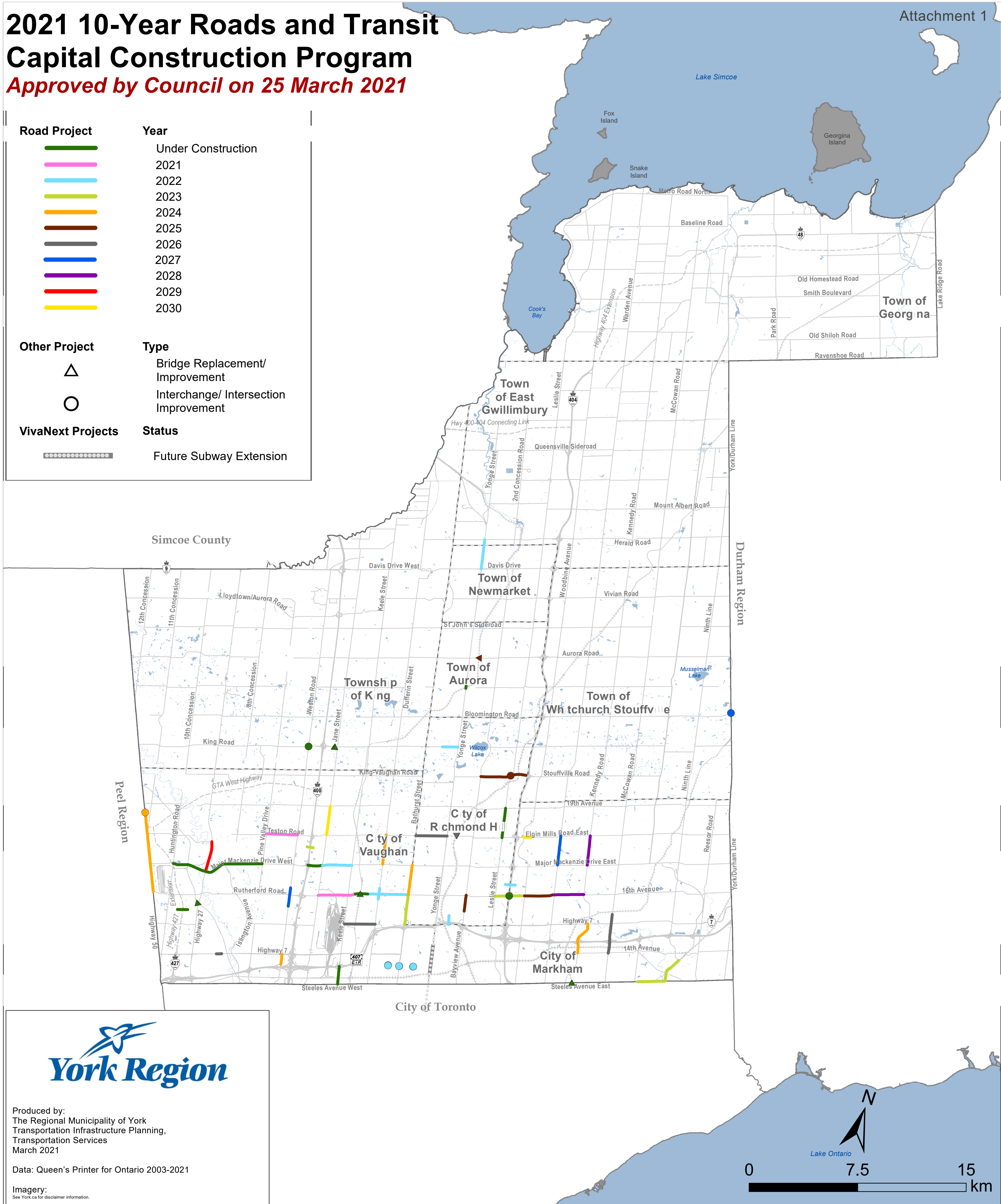

Produced by:
The Regional Municipality of York
Transportation Infrastructure Planning,
Transportation Services
March 2021

Data: Queen's Printer for Ontario 2003-2021

Imagery:
See York.ca for disclaimer information.

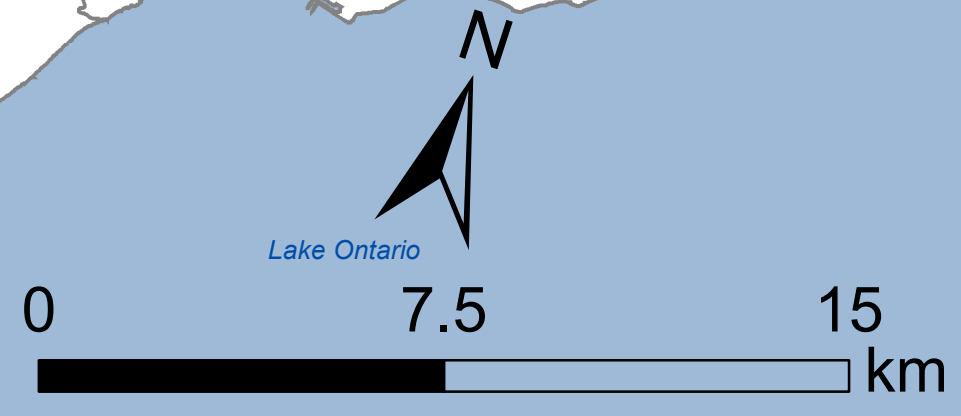

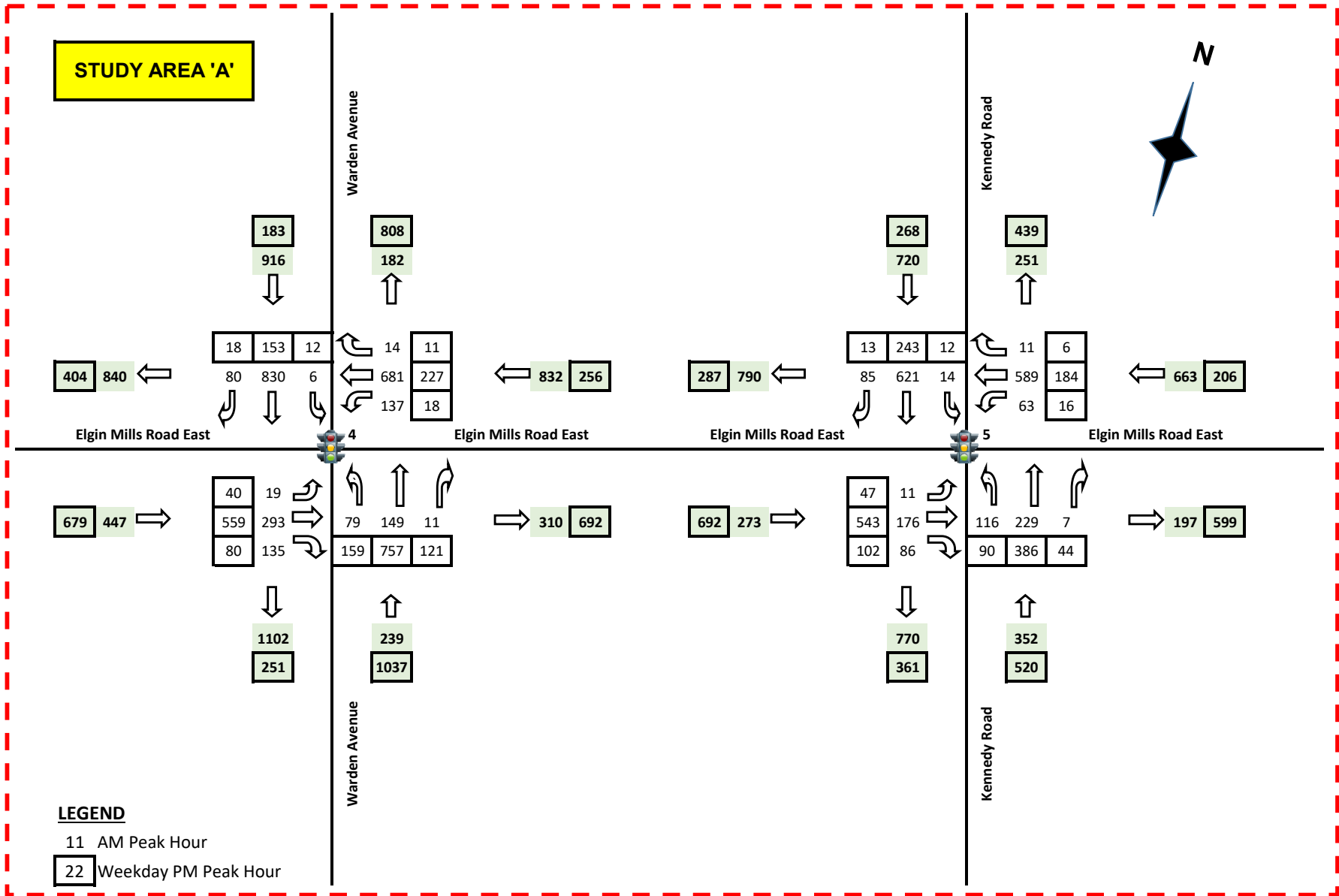

Exhibit 8-1

2021 Existing Traffic Volumes Study Area 'A' – AM and PM Peak Hours

Environmental Assessment Study Elgin Mills Road East, City of Markham - Transportation Study



Existing Year Existing Construction Year	2021	Peak Hour	Total Truck%	Medium/Heavy Split	normalized to existing year				
	AADT				2023	2027	2028	2031	2041
Kennedy Road	7,910	1,179	3%	40%/60%	8392	9083	9265	10630	12958
Warden Avenue - between Major Mackenzie Drive and Heritage Hill Drive	12,427	1,278	5%	40%/60%	13184	14271	14556	16701	20359
Major Mackenzie Drive	25,090	2,941	3%	50%/50%	25342	25852	25981	26373	27722
Elgin Mills Roads	11,050	1,105	2%	70%/30%	12651	16583	17744	21737	22849

Kennedy Road- between Major Mackenzie Drive and Elgin Mills Road**Posted Speed** 80 km/hr**Northbound**

50th Percentile 77 kph

85th Percentile 86 kph

Volume Weighted Speed 77 kph

Southbound

50th Percentile 84 kph

85th Percentile 94 kph

Volume Weighted Speed 84 kph

Warden Avenue - between Major Mackenzie Drive and Heritage Hill Drive**Posted Speed** 60 km/hr**Northbound**

50th Percentile 64 kph

85th Percentile 70 kph

Volume Weighted Speed 64 kph

Southbound

50th Percentile 75 kph

85th Percentile 82 kph

Volume Weighted Speed 75 kph

Warden Avenue - between Major Mackenzie Drive and Heritage Hill Drive**Posted Speed** 80 km/hr**Northbound**

50th Percentile 77 kph

85th Percentile 86 kph

Volume Weighted Speed 77 kph

Southbound

50th Percentile 84 kph

85th Percentile 94 kph

Volume Weighted Speed 84 kph



BURNSIDE

[THE DIFFERENCE IS OUR PEOPLE]

Appendix B

Sample Noise Calculations

Description From ESDM	Distance Between Source & Receptor (m)	Reference Sound Level (dBA)	Reference Distance (m)	Predicted SPL at POR (dBA)	Duration (min)
Warden Avenue	150.0	62.86	41.06	51.6	60
Kennedy Road	150.0	62.26	32.4	48.9	60

Since the predicted impacts at 150 m are below the MECP objective sound level for an OLA 150 m is a valid study area size.

Filename: por3est.te Time Period: Day/Night 16/8 hours
 Description: POR3 Construction Year

Road data, segment # 1: Warden (day/night)

```
-----
Car traffic volume : 12202/1356 veh/TimePeriod *
Medium truck volume : 257/29 veh/TimePeriod *
Heavy truck volume : 385/43 veh/TimePeriod *
Posted speed limit : 86 km/h
Road gradient : 2 %
Road pavement : 1 (Typical asphalt or concrete)
```

* Refers to calculated road volumes based on the following input:

```
24 hr Traffic Volume (AADT or SADT): 14271
Percentage of Annual Growth : 0.00
Number of Years of Growth : 0.00
Medium Truck % of Total Volume : 2.00
Heavy Truck % of Total Volume : 3.00
Day (16 hrs) % of Total Volume : 90.00
```

Data for Segment # 1: Warden (day/night)

```
-----
Angle1 Angle2 : -90.00 deg 90.00 deg
Wood depth : 0 (No woods.)
No of house rows : 0 / 0
Surface : 1 (Absorptive ground surface)
Receiver source distance : 41.06 / 41.06 m
Receiver height : 4.50 / 4.50 m
Topography : 1 (Flat/gentle slope; no barrier)
Reference angle : 0.00
```

Results segment # 1: Warden (day)

Source height = 1.32 m

ROAD (0.00 + 63.20 + 0.00) = 63.20 dBA

Angle1	Angle2	Alpha	RefLeq	P.Adj	D.Adj	F.Adj	W.Adj	H.Adj	B.Adj	SubLeq
-90	90	0.58	71.40	0.00	-6.89	-1.31	0.00	0.00	0.00	63.20

Segment Leq : 63.20 dBA

Total Leq All Segments: 63.20 dBA

Results segment # 1: Warden (night)

Source height = 1.32 m

ROAD (0.00 + 56.69 + 0.00) = 56.69 dBA

Angle1	Angle2	Alpha	RefLeq	P.Adj	D.Adj	F.Adj	W.Adj	H.Adj	B.Adj	SubLeq
--------	--------	-------	--------	-------	-------	-------	-------	-------	-------	--------

-90	90	0.58	64.89	0.00	-6.89	-1.31	0.00	0.00	0.00	56.69
-----	----	------	-------	------	-------	-------	------	------	------	-------

Segment Leq : 56.69 dBA

Total Leq All Segments: 56.69 dBA

TOTAL Leq FROM ALL SOURCES (DAY): 63.20
(NIGHT): 56.69

Filename: por3nb.te Time Period: Day/Night 16/8 hours
 Description: POR3 Mature State

Road data, segment # 1: Warden (day/night)

```
-----
Car traffic volume : 17407/1934 veh/TimePeriod *
Medium truck volume : 366/41 veh/TimePeriod *
Heavy truck volume : 550/61 veh/TimePeriod *
Posted speed limit : 86 km/h
Road gradient : 2 %
Road pavement : 1 (Typical asphalt or concrete)
```

* Refers to calculated road volumes based on the following input:

```
24 hr Traffic Volume (AADT or SADT): 20359
Percentage of Annual Growth : 0.00
Number of Years of Growth : 0.00
Medium Truck % of Total Volume : 2.00
Heavy Truck % of Total Volume : 3.00
Day (16 hrs) % of Total Volume : 90.00
```

Data for Segment # 1: Warden (day/night)

```
-----
Angle1 Angle2 : -90.00 deg 90.00 deg
Wood depth : 0 (No woods.)
No of house rows : 0 / 0
Surface : 1 (Absorptive ground surface)
Receiver source distance : 41.06 / 15.00 m
Receiver height : 4.50 / 4.50 m
Topography : 1 (Flat/gentle slope; no barrier)
Reference angle : 0.00
```

Results segment # 1: Warden (day)

Source height = 1.32 m

ROAD (0.00 + 64.75 + 0.00) = 64.75 dBA

Angle1	Angle2	Alpha	RefLeq	P.Adj	D.Adj	F.Adj	W.Adj	H.Adj	B.Adj	SubLeq
-90	90	0.58	72.95	0.00	-6.89	-1.31	0.00	0.00	0.00	64.75

Segment Leq : 64.75 dBA

Total Leq All Segments: 64.75 dBA

Results segment # 1: Warden (night)

Source height = 1.32 m

ROAD (0.00 + 65.11 + 0.00) = 65.11 dBA

Angle1 Angle2 Alpha RefLeq P.Adj D.Adj F.Adj W.Adj H.Adj B.Adj SubLeq

-90 90 0.58 66.42 0.00 0.00 -1.31 0.00 0.00 0.00 65.11

Segment Leq : 65.11 dBA

Total Leq All Segments: 65.11 dBA

TOTAL Leq FROM ALL SOURCES (DAY): 64.75
(NIGHT): 65.11

Filename: ola3ext.te Time Period: Day/Night 16/8 hours
 Description: OLA3 Construction Year

Road data, segment # 1: Warden (day/night)

```
-----
Car traffic volume : 12202/1356 veh/TimePeriod *
Medium truck volume : 257/29 veh/TimePeriod *
Heavy truck volume : 385/43 veh/TimePeriod *
Posted speed limit : 86 km/h
Road gradient : 2 %
Road pavement : 1 (Typical asphalt or concrete)
```

* Refers to calculated road volumes based on the following input:

```
24 hr Traffic Volume (AADT or SADT): 14271
Percentage of Annual Growth : 0.00
Number of Years of Growth : 0.00
Medium Truck % of Total Volume : 2.00
Heavy Truck % of Total Volume : 3.00
Day (16 hrs) % of Total Volume : 90.00
```

Data for Segment # 1: Warden (day/night)

```
-----
Angle1 Angle2 : -90.00 deg 45.00 deg
Wood depth : 0 (No woods.)
No of house rows : 0 / 0
Surface : 1 (Absorptive ground surface)
Receiver source distance : 46.00 / 46.00 m
Receiver height : 4.50 / 1.50 m
Topography : 1 (Flat/gentle slope; no barrier)
Reference angle : 0.00
```

Results segment # 1: Warden (day)

Source height = 1.32 m

ROAD (0.00 + 61.55 + 0.00) = 61.55 dBA

Angle1	Angle2	Alpha	RefLeq	P.Adj	D.Adj	F.Adj	W.Adj	H.Adj	B.Adj	SubLeq
-90	45	0.58	71.40	0.00	-7.67	-2.18	0.00	0.00	0.00	61.55

Segment Leq : 61.55 dBA

Total Leq All Segments: 61.55 dBA

Results segment # 1: Warden (night)

Source height = 1.32 m

ROAD (0.00 + 54.52 + 0.00) = 54.52 dBA

Angle1	Angle2	Alpha	RefLeq	P.Adj	D.Adj	F.Adj	W.Adj	H.Adj	B.Adj	SubLeq
--------	--------	-------	--------	-------	-------	-------	-------	-------	-------	--------

-90	45	0.66	64.89	0.00	-8.08	-2.29	0.00	0.00	0.00	54.52
-----	----	------	-------	------	-------	-------	------	------	------	-------

Segment Leq : 54.52 dBA

Total Leq All Segments: 54.52 dBA

TOTAL Leq FROM ALL SOURCES (DAY): 61.55
(NIGHT): 54.52

Filename: ola3nb.te Time Period: Day/Night 16/8 hours
 Description: OLA3 Mature State

Road data, segment # 1: Warden (day/night)

```
-----
Car traffic volume : 17407/1934 veh/TimePeriod *
Medium truck volume : 366/41 veh/TimePeriod *
Heavy truck volume : 550/61 veh/TimePeriod *
Posted speed limit : 86 km/h
Road gradient : 2 %
Road pavement : 1 (Typical asphalt or concrete)
```

* Refers to calculated road volumes based on the following input:

```
24 hr Traffic Volume (AADT or SADT): 20359
Percentage of Annual Growth : 0.00
Number of Years of Growth : 0.00
Medium Truck % of Total Volume : 2.00
Heavy Truck % of Total Volume : 3.00
Day (16 hrs) % of Total Volume : 90.00
```

Data for Segment # 1: Warden (day/night)

```
-----
Angle1 Angle2 : -90.00 deg 45.00 deg
Wood depth : 0 (No woods.)
No of house rows : 0 / 0
Surface : 1 (Absorptive ground surface)
Receiver source distance : 46.00 / 46.00 m
Receiver height : 4.50 / 1.50 m
Topography : 1 (Flat/gentle slope; no barrier)
Reference angle : 0.00
```

Results segment # 1: Warden (day)

Source height = 1.32 m

ROAD (0.00 + 63.10 + 0.00) = 63.10 dBA

Angle1	Angle2	Alpha	RefLeq	P.Adj	D.Adj	F.Adj	W.Adj	H.Adj	B.Adj	SubLeq
-90	45	0.58	72.95	0.00	-7.67	-2.18	0.00	0.00	0.00	63.10

Segment Leq : 63.10 dBA

Total Leq All Segments: 63.10 dBA

Results segment # 1: Warden (night)

Source height = 1.32 m

ROAD (0.00 + 56.05 + 0.00) = 56.05 dBA

Angle1	Angle2	Alpha	RefLeq	P.Adj	D.Adj	F.Adj	W.Adj	H.Adj	B.Adj	SubLeq
--------	--------	-------	--------	-------	-------	-------	-------	-------	-------	--------

-90	45	0.66	66.42	0.00	-8.08	-2.29	0.00	0.00	0.00	56.05
-----	----	------	-------	------	-------	-------	------	------	------	-------

Segment Leq : 56.05 dBA

Total Leq All Segments: 56.05 dBA

TOTAL Leq FROM ALL SOURCES (DAY): 63.10
(NIGHT): 56.05



BURNSIDE

[THE DIFFERENCE IS OUR PEOPLE]

Appendix C

Municipal Noise Standards

Transportation Services - York Region

Standard Operating Procedures (SOP's) for Traffic Noise Mitigation on Regional Roads

November 2019

**Prepared in consultation with the Consulting Engineering Firm
"SS Wilson Associates, Richmond Hill, ON"**

Table of Contents

PURPOSE OF THESE STANDARD OPERATING PROCEDURES (SOP'S)	4
DEFINITIONS	4
SCENARIO A – CAPITAL PROGRAM PROJECTS	10
Purpose.....	10
Establishment of the Sound Levels	10
Road and Traffic Data.....	10
Road Traffic Sound Level Predictions	11
Bus Transit Corridor Sound Level Predictions	11
Ambient Sound Levels Due to Other Sources of Noise	12
Impact on Future Developments	12
Weekend Traffic or Summer Traffic	12
Operational Statements from Council (TWC Report No. 3 – March 23, 2006).....	13
Case Scenario Guidelines.....	13
SCENARIO B – RETROFIT APPLICATIONS	14
Purpose.....	14
Requests for Retrofitting.....	14
Candidate Sites	14
Exclusions & Limitations of the Policy	14
Noise Sensitive Points of Reception.....	15
Sound Level Criteria	15
Noise Barrier Technical Criteria	16
Construction and Maintenance	16
Costs and Priority	17
York Region Staff Responsibilities	17
SCENARIO C – DEVELOPMENT PLANNING APPLICATIONS.....	20
Purpose.....	20
Noise Assessment Criteria	20
Noise Impact Assessment	20
Prediction of Road Traffic Noise	21
Application of Criteria	21
Assessment Locations	22

SCENARIO D – REPLACEMENT APPLICATIONS	23
Purpose.....	23
Noise Wall Safety Criteria	23
MATERIAL STANDARDS & CONSTRUCTION SPECIFICATIONS	23

- - -

STANDARD OPERATION PROCEDURES SUPPLEMENT DOCUMENT:

Case Scenario Guidelines – Noise Sensitive Uses	34
Case Scenario Guidelines – Land Compatibility	35
Case Scenario Guidelines – Community Integration	38

- - -

YORK REGION – STANDARD WOODEN NOISE BARRIER DRAWINGS:

Cover Sheet	41
Index Sheet	42
Sheet “A” – Standard Noise Barrier Location	43
Sheet “B 1” – Elevation View: Flat Grade Installation	44
Sheet “B 2” – Elevation View: Sloping Grade Installation	45
Sheet “C” – Post & Base Construction Detail	46
Sheet “D” – Post, Rail, Coping & Construction Fastening Detail	47
Sheet “E” – Post & Post Capping Detail	48
Sheet “F” – Exploded View – Board on Board Fastening Detail	49
Sheet “G” – Material & Finishing Detail	50
Sheet “H” – Aesthetic Enhancements	51

PURPOSE OF THESE STANDARD OPERATING PROCEDURES (SOP'S)

The purpose of these SOP's is to ensure that fundamental design and calculation criteria is identified in order to meet York Region standards for traffic noise control on Regional roads and bus transit corridors for the following scenarios:

- Scenario A – Capital Program Projects
- Scenario B – Retrofit Applications
- Scenario C – Development Planning
- Scenario D – Replacement Applications

Staff, developers and consultants that incorporate these criteria will ensure that:

- Environmental Assessment Act requirements have been met
- York Region's Traffic Noise Mitigation Policy for regional roads have been met
- Ministry of Environment protocol, guidelines and design criteria have been met
- York Region Official Plan objectives have been met
- York Region transportation planning and design practices have been met
- Local Municipality requirements have been met

Each scenario has been individually identified in order to capture the key elements that need to be examined and incorporated into the noise study so that the appropriate noise mitigation is ensured.

Staff, developers and consultants shall familiarize themselves with the applicable sections when preparing noise study reports and mitigation options.

DEFINITIONS

A weighted decibel; dBA A nationally and internationally standardized frequency weighting applied to the sound level (measured in decibels) spectrum to approximate the sensitivity of the human hearing mechanism as a function of frequency (pitch).

AADT "Annual Average Daily Traffic" is defined as the average twenty-four hour, two-way traffic for the period January 1st to December 31st.

Adverse effect means one or more of the following effects of sound and vibration, selected from the relevant definitions in the Environmental Protection Act:

- impairment of the quality of the natural environment for any use that can be made of it;
- cause harm or material discomfort to any person;
- create an adverse effect on the health of any person
- loss of enjoyment of normal use of property.
- Interfere with the normal conduct of business
- Rendering any property unfit for use by man

Ambient sound level means background sound level.

Acoustic "Shadow Zone" (and Acoustic "Bright Zone") Acoustic "Shadow Zone" is the area behind a sound barrier with no direct line-of-sight from the receptor to the source where the sound wave may diffract (bend) around the barrier. The Acoustic "Bright Zone" is the area around a sound barrier with direct line-of-sight from the receptor to the source.

Acoustic Insulation Factor (AIF) is a technical descriptor developed by the National Research Council of Canada (NRC) to signify the ability of a structure or an assembly to reduce the noise from the outside to the inside of a building based on specified indoor design conditions.

Acoustical Consultant is a Professional Engineer (P.Eng.), licensed by the Professional Engineers of Ontario (PEO) to practice in the Province of Ontario, and with demonstrated experience in the field of acoustics and noise control as partly defined by the PEO professional practice Guidelines for Professional Engineers Providing Acoustical Engineering Services in Land-Use Planning.

Aesthetics in the context of this guideline document, refer to the methods of providing visual relief and appealing characteristics to planned *noise barriers* through the application of landscaping designs and aesthetic treatment.

Airborne Sound is sound that reaches the point of interest by propagation through air.

Ambient/ Background Sound Level in general, it is the all-encompassing noise associated with a given environment and comprises a composite of sounds from many sources near and far. In the context of roadway environmental noise assessment, the ambient or existing noise level is the noise level which exists at a receptor as a result of existing traffic conditions without the addition of noise generated by the proposed undertaking or the new source of noise. Highly intrusive short duration noise caused by a source such as an aircraft flyover or a train pass-by is excluded from the determination of the background sound level.

A-Weighted sound level The “A-weighted sound level” is a *sound pressure level* indicated by a measurement system that includes an *A-weighted* network. The resulting value is in *decibels* and commonly labeled *dBA*.

A-Weighting is a frequency weighting intended to approximate the relative sensitivity of the normal human ear to different frequencies (itches of sound) .The specific variation of sensitivity with frequency to conform to IEC Publication 651.

dBA means the A-weighted sound pressure level.

Decibel is the common measure of sound level or sound pressure level. It is the term to identify 10 times the common logarithm of the ratio of two like quantities proportional to power or energy. The “decibel” is a dimensionless measure of sound level or sound pressure level; see sound pressure level.

Engineer or Consulting Engineer (Structural) For the purpose of this document, in connection with the design of Noise/Sound Barriers, shall mean the Professional Engineer or the Engineering firm licensed by the Professional Engineers of Ontario (PEO) to practice structural engineering which is engaged by the Supplier and/or project proponent to design and certify the noise barrier system. The Engineer shall have documented experience in the design, construction and review of Structural Engineering Projects as required and in accordance with the Guidelines for Professional Engineering Services prepared by the Professional Engineers of Ontario.

Environmental Noise is noise transmitted through the outdoor environment as opposed to noise generated and contained within buildings.

First Row Receiver is a term used to define all those receivers (or receptors) adjacent to a Region of York transportation corridor where sound level differences are imperceptible (within 3 dBA) from the noisiest receiver.

Frequency (Pitch) is the number of complete oscillations (or cycles) per second of a periodically varying quantity (e.g. pressure, displacement). The unit is the Hertz (Hz).

Geotechnical Engineer is a Professional Engineer (P. Eng.) licensed by the Professional Engineers of Ontario (PEO) to practice in the Province of Ontario, with demonstrated expertise in the field of geotechnical engineering as defined by the PEO Guidelines for Professional Engineers Providing Geotechnical Engineering Services.

Indoor sound level is an estimated/calculated sound level in the central part of a room.

Leq – The Energy Equivalent Continuous Sound Level is the constant sound level over the time period in question, that results in the same total sound energy as the actually varying sound. It must be associated with a time period. Leq is a measure of total sound energy dose over a specified time period.

Leq (T): Leq (16 hours), Leq (8 hours) or Leq (1 hours) means the A-weighted level of a steady sound carrying the same total energy in the time period T as the observed fluctuating sound. The time period T is given in brackets.

Mature State of Development is the future build-out of development to the ultimate population and traffic capacity forecasts corresponding to the Official Plan of the Region.

Noise is defined as any unwanted sound.

Noise Attenuation Features is any feature or combination of features such as noise abatement walls, earth berms, building configuration and building materials (not intended to be a complete list) which provide a reduction in noise level for noise sensitive outdoor living areas.

Noise Barrier is a physical structure planned or otherwise, which is located between a noise source and a noise sensitive receptor and effects a reduction in sound level transmission from the source to the receptor. Noise barriers, in general, include walls, berms or combinations thereof, buildings and natural or deliberately created land features.

Noise Reduction (NR) is the difference in sound level between two adjacent spaces.

Noise Reduction Coefficient (NRC) is a single-number rating of the sound-absorptive property of a material. It is calculated as the average of the sound-absorption coefficients, measured in accordance with ASTM Test Method C423, at 250, 500, 1000 and 2000 Hz, and rounded to the nearest multiple of 0.05.

Noise Control measure refers to action which can be taken to reduce the sound levels inside and/or outside the buildings of concern and achieve compatibility for the specific land use or activity. Control measures may include, but are not limited to, the following:

- **Site Planning** - orientation of buildings and Outdoor Living Areas with respect to noise sources, spatial separation such as the insertion of noise insensitive land uses between source and receiver, appropriate setbacks, the use of intervening service roads and site planning techniques;
- **Acoustical Barriers** - berms, walls or a combination thereof, favorable topographical features, other intervening structures;
- **Architectural Design** - room and corridor arrangement, blank walls, placement of windows, balconies, courtyards and building height;

- **Building Construction** - acoustical treatment of walls, ceilings, selection of acoustical materials and other control devices;
- **Mitigation at Source** - noise control applied directly to the noise source;
- **Windows/Doors** - acoustically selected windows or doors that provide the required noise reduction.
- **Central Air Conditioning** - in order to allow for the windows and doors to remain closed, central air conditioning (mechanical ventilation and climatic control system) is necessary. Provision for future installation of air conditioning may also be necessary in lower noise level cases.
- **Capital Projects** - where capital road construction projects are being undertaken on regional roads.
- **Development** - development or redevelopment affected by regional roads.
- **Retrofit** - existing residential areas that may warrant noise mitigation due to regional roads and/or bus transit corridors where no Capital Road Projects are being undertaken.

Noise Sensitive Areas (NSA)/Land Use: These are any outdoor living areas associated with noise-sensitive buildings. The following land uses, with OLA's associated with them would qualify as NSA's: private homes such as single and semi-detached family residences; townhouses; multiple unit buildings such as apartments with OLA's for use by all occupants; hospitals or nursing homes where there are OLA's for the patients and day care facilities.

Noise Sensitive Land Use means a land use that is sensitive to noise, whether inside and/or outside the property and that must be planned and/or designed using appropriate land use compatibility principles. Examples of sensitive land uses include:

- Residential developments;
- Seasonal residential developments;
- Hospitals, nursing/retirement homes, schools, day-care centres;
- Other land uses that may contain indoor and/or outdoor areas/spaces where an intruding noise may create an adverse effect.

In general, a noise-sensitive land use could be any type of land use where environmental noise is likely to cause an *adverse effect* or material discomfort whether inside or outside of a building.

Noise/Sound Barrier System as referred to in this document, refers to the noise barrier as a system which includes the panels, posts, foundation, methods of design and construction details, finish and all other components as approved by the Region for inclusion in the Region's List of Approved Suppliers.

Noise/Sound Barrier Walls are free standing walls/structures made of concrete, wood, metal, vinyl or composite walls installed for the purpose of reducing the noise levels on adjacent properties.

Official Plan (OP) means the approved Official Plan of the Region.

Official Plan Amendment (OPA) means an approved amendment of part(s) of the Official Plan of the Region.

Outdoor Living Area (OLA) is the part of an outdoor amenity area provided for the quiet enjoyment of the outdoor environment. The OLA is typically an area at ground level accommodating outdoor living activities. For sound level calculation purposes, the usual distance from the dwelling unit wall is up to 3m, located near the mid-length of the corresponding side of the dwelling. The vertical height is 1.5 meters above the ground level. Where unknown, the side closest to the source of noise should be assumed. Paved areas for

multiple dwelling residential units may not be defined as OLA. The OLA may include private areas used by individual dwelling occupants or “common” areas used by multi-tenant dwelling occupants. The OLA is also the part of an outdoor area easily accessible from the building and designed for the quiet enjoyment of the outdoor environment. Outdoor Living Areas include, but are not limited to, the following:

- Backyards, front yards, gardens, terraces or patios;
- Balconies, provided they are the only Outdoor Living Areas for the occupant and meet the following conditions; minimum depth of 4 m, outside the exterior building facade, unenclosed
- Common Outdoor Living Areas associated with multi-storey apartment buildings or condominiums that are noise-sensitive;
- Passive recreational areas such as parks if identified by the City for such use.

Panel The panel component of a noise barrier is that portion which, when joined together, produces a solid wall. In most cases, the panels span the distance between supports.

Points of Reception - Points of Reception are defined as residential noise sensitive areas along a Regional surface transportation corridor where it may receive "unacceptable" sound level.

The following land uses, with OLA's associated with them would qualify as points of reception under the above criteria:

- Private homes such as single family residences;
- Townhouses and
- Multiple unit buildings, such as apartments with OLA's for use by all occupants

Land uses listed below, by themselves do not qualify; except as previously defined in the “Noise Sensitive Land Use” as points of reception:

- Apartment or house balconies above ground floor;
- Educational facilities (except dormitories with OLA's)
- Places of Worship;
- Cemeteries or funeral homes;
- Public/Private Parks and picnic areas;
- All commercial areas;
- All industrial areas

Posts Are usually considered as vertical supports for the noise barrier panels.

Roadway includes a common public roadway, street, avenue, parkway, driveway or part of a roadway on a bridge or trestle which is intended for or used by the general public for the passage of vehicles and includes the area between the lateral property lines thereof.

Rural Area Where the sound environment is dominated by the sounds of nature and road traffic, if any, is infrequent.

SADT “Summer Average Daily Traffic”; defined as the average twenty-four hour, two-way traffic for the period 1 July to 31 August, including weekends.

Sound is a fluctuation in pressure, particle displacement or particle velocity propagated in any medium; or the auditory sensation that may be produced by it.

Sound Level is the A-weighted sound pressure level in dBA.

Sound Pressure Level (Lp) is 10 times the common logarithm of the ratio of the mean square pressure of a sound to the square of the reference pressure of 20 micro Pascal. Thus, the sound pressure level is expressed in decibels.

Sound Transmission Class (STC) is a single-number rating of the capacity of a structure to prevent sound from reaching a receiving location. It is calculated in accordance with ASTM Classification E413 using values of sound-transmission loss measured in accordance with ASTM Test Method E90. It provides an estimate of the performance of a partition in dealing with certain common sound insulation problems.

Standard Operating Procedures (SOP's) York Region's technical guidelines for the assessment and mitigation of noise due to regional roads and bus transportation corridors.

Start Of Construction is the anticipated construction year of a given road project segment as identified in the Region's 10-Year Roads Capital Construction Program. Beyond this Program, it is considered to be a placeholder year representing the following year after the ending year of the active (or expected) 10-Year Construction Program when completion of the environmental assessment is planned.

Stationary Source of Noise For the purpose of this document, a stationary source of noise is defined as: "Stationary source means all sources of sound/vibration; whether fixed or mobile, that exist/operate on the premises, property or facility, the combined sound/vibration levels of which are emitted beyond the property boundary of the premises, property or facility, unless the source(s) is (are) due to temporary "construction" as defined in the applicable municipal noise By-Law."

Supplier Refers to the manufacturer of the noise barriers / noise barrier system and/or its representative responsible for making the necessary technical submissions to the Region as well as the supply of the noise barrier system components. A list of York Region approved suppliers can be found on page 31 of this document.

Time Periods (MOE predefined time periods) "Day-time" is the 16-hour period between 07:00 and 23:00 hours. "Night-time" is the 8-hour period between 23:00 and 07:00 hours.

Bus Transit Corridor is defined as a roadway designed for the use by buses only and/or other vehicles.

Urban Area Where the sound environment is dominated by the activities of man

Warning Clause (Or "environmental warning/restriction") means a notification of or obligation to notify a potential purchaser of some environmental concern; in this case the concern is potential annoyance due a source of noise (Its application is not intended for stationary sources of noise).

SCENARIO A – CAPITAL PROGRAM PROJECTS

Purpose

The purpose of this SOP is to ensure that fundamental technical data is collected, interpreted and correctly used in evaluating noise mitigation on regional roads and bus transit corridors during road reconstruction projects.

The following criteria must be established:

Establishment of the Sound Levels

The daytime sound levels Leq 16hr should be established using prediction models acceptable to the Region. Actual field measurements may be used subject to York Region's prior approval, to deal with situations that may not be feasible to predict such as:

- Unusual traffic patterns or the presence of high percentages of vehicle classifications beyond those reported by the Region
- Traffic or roadway parameters that are outside of the limitations of the prediction model
- Downtown core areas
- The presence of large reflecting structures in dense urban areas
- Highly irregular topography
- The presence of other stationary sources of noise
- The presence of complicated geometrics for calculation purposes

Actual field measurements, if deemed necessary, are to be performed in accordance with the MOE procedures and generally accepted acoustic and traffic engineering principles.

Road and Traffic Data

The acoustic consultant shall secure accurate and reliable traffic data, such as volume, speed and composition of existing traffic conditions, as well as traffic projections for the planned Capital Construction Program year and for the mature state of development year at the time of preparing the environmental traffic noise assessment. The “*Start of Construction*” and “*Mature State of Development*” years are defined at the beginning of this SOP.

In general, the traffic data shall consist of the following:

1. Volume of vehicles moving on hourly basis (two-directional)
2. Traffic Day/Night Split (percentage of all vehicles moving during the period from 7 a.m. to 11 p.m. and other volume moving from 11 p.m. to 7 a.m.)
3. Speed statistics (50th percentile, 85th percentile and volume weighted speed)
4. Traffic mix (percentage of vehicles, automobiles, medium trucks and heavy trucks).
5. The above information should be collected for minimum 3 full days during the weekdays (Tuesday, Wednesday, Thursday)

Where projects include road sections not shown in the Region’s Road Construction Program, the acoustic consultant shall document provisions in the environmental assessment noise study to update the study in the future where construction is beyond 10 years of the assumed start of construction year. In particular, the noise study shall clearly indicate differing areas of planned construction commitments and possible *future construction commitments* by the Region, which *would be reviewed and updated in the future* should the start of construction year not be known.

Road Traffic Sound Level Predictions

1. Road traffic noise shall be predicted by the Ontario Road Noise Analysis Method for Environment and Transportation (ORNAMENT) or by using the computerized version STAMSON
2. The noise study report shall detail information on all required adjustments to the model where applicable
3. Where there is more than one roadway noise source, the calculation of the combined sound levels is required
4. When predicting the sound levels due to regional roads, the following points shall be adhered to in the analysis and assessment:
 - a) Curved road sections, roads with varying grade elevations, four and more lane roadways and areas with multipart sound barriers/physical screening are to be assessed on the basis of multiple segments (e.g., upstream, downstream, traffic direction, localized screening).
 - b) Where sound barriers are involved in the analysis, calculations shall be performed at locations not exceeding five lots and/or dwellings.
 - c) Reliable grade elevations at the receptors, barrier base elevations and road elevations shall be established and included in the study.
 - d) The majority of barrier segments, where sound barriers are involved, should be in the acoustic “shadow zone”. The use of acoustic “bright zones” is not acceptable, except for the remote segments.
 - e) The higher of the posted speed limit and actual driving speed (based on the 85th percentile) shall be used in the calculation of the sound levels.
 - f) Where heavy truck percentages exceed 5% of the total traffic volume and where sound barrier(s) are warranted, additional and supplementary analysis shall be included in the study by separating the analysis of each vehicle class separately prior to combining the sound levels of all vehicle categories.
 - g) All receptors that may have an outdoor noise sensitive land use component are to be identified and addressed in the study.
 - h) Where the receptors are outfitted with existing sound barrier(s), the study shall address the sound levels with such barrier(s). The general condition of the barrier that affects their acoustic performance shall be included in the noise study together with appropriate conclusions and recommendations.

Bus Transit Corridor Sound Level Predictions

1. Bus movements between stations along the open at-grade sections of the bus transit corridor to be modeled using the ORNAMENT model based on knowledge of the applicable future bus movements by the Region.
2. For a bus transit terminal, other calculation routines and/or models must account for all noise events generated by a typical station based on the MOE “Stationary Sources” criteria.

Factors affecting the overall hourly Leq due to a typical terminal must be included in the assessment.

The input data and the various assumptions used shall be clearly documented in the report.

Ambient Sound Levels Due to Other Sources of Noise

Ambient sound levels due to other sources of noise will be established by procedures acceptable to the Region.

Reference should be made to applicable MOE guideline publications and procedures.

Impact on Future Developments

During the preparation of a noise study for a capital works project, the Consultant must obtain information from the Planning and Development Department in the area municipality and York Region on future development applications in proximity to the proposed regional road and/or bus transit corridor undertaking for further examination.

The information shall include:

- Copies of the relevant plans
- Status of approvals by the approval authorities
- Existing or proposed grade elevations of the proposed development

Copies of noise study reports that may have been submitted by the proponent to the approval authorities, etc.

The Acoustical Consultant shall review all relevant information in these documents for noise and their recommended noise control measures. The results of this review shall be compared with the relevant technical details related to noise assessment of the subject undertaking and differences or inconsistencies; if any, should be noted and reported.

York Region shall be advised of any discrepancies in the resulting sound levels and the extent of noise mitigation for both; the development side and the subject undertaking.

Weekend Traffic or Summer Traffic

While the use of the AADT for noise assessments is the common practice, special consideration may be given to situations where the weekend traffic or summer traffic (SADT) may be more dominant.

Appropriate adjustments to the calculated sound level shall, then be applied in such situations.

The results and recommendations in this respect shall be implemented.

Operational Statements from Council (TWC Report No. 3 – March 23, 2006)

Tree Removal & Compensation: Tree removal will be avoided wherever possible. However, tree removal will be required in many instances where trees are located on or close to the property line. Compensation will be provided where privately owned trees are removed in the form of either replacement trees or financial compensation. Where removal is required for trees within the public right-of-way landscaping will be provided on the public side of the noise barrier.

Noise Mitigation Warrants: On capital road projects where noise mitigation is warranted it will only be implemented where it will be effective. In situations where noise levels warrant mitigation but it is not implemented due to the inability for it to noticeably reduce noise levels (i.e. to protect the OLA due to changing topography), it is recommended that staff be authorized to provide additional tree planting on the public right-of-way where space permits to assist in providing visual screening from the road. The type and location of trees to be planted will be at the discretion of regional staff.

Existing Noise Barriers: On capital projects where privately owned noise barriers already exist along reverse frontage properties new noise mitigation will not be provided. At the time when those developments were approved it was identified that noise levels warranted noise mitigation due to traffic on the Regional road. Purchasers of these homes knowingly assumed the responsibility of maintaining the noise barriers provided by the developer as part of their home purchase. In addition to development approval records, as part of the noise policy update study a complete inventory of the types and condition of privately owned noise barriers along Regional roads was completed. Attempts by private owners to remove existing noise fences in order to qualify for new noise barriers as part of a York Region capital project will be denied and these owners will be required to reinstate the noise barrier through enforcement of municipal property standards by-laws.

Case Scenario Guidelines

On capital projects, different situations may arise where property, land-use, or mitigation use may need to be considered in special context during the preparation of the noise study. Where the identified situations exist, the Region has provided additional guidance to be used for handling specific case scenarios. The Acoustical Consultant shall use the guidelines to develop a common approach throughout the study for the purposes of assessment and design.

Refer to page 34 for the attached SOP Supplement Document: Case Scenario Guidelines.

- Noise Sensitive Uses – Special property cases
- Land Compatibility – Alternative barrier alignment cases
- Community Integration – Barrier layout site evaluation cases

The supplement guidelines are to be followed and used as an inclusive part of the Standard Operating Procedures for Capital road projects.

SCENARIO B – RETROFIT APPLICATIONS

Purpose

The purpose of this SOP is to establish the technical criteria and priority scheme for determining where retrofit noise mitigation is to be implemented on a Region-wide basis, responsibilities for retrofitting noise barrier construction and maintenance costs and how owners/residents can petition the Region.

Requests for Retrofitting

A petition requesting the installation of a noise attenuation barrier must be signed by the landowner as required under the Municipal Act and submitted to the Clerk of the Region.

At least two-thirds of the affected property owner(s) representing at least one-half of the required properties to qualify for the work must sign the petition to qualify for the retrofit project.

Candidate Sites

All existing residential development on sections of Regional Road allowances which have existing reverse frontage/flanking homes and meet the York Region's Policy criteria for retrofit locations will be considered on a case by case basis by Regional Council.

The prioritization of these sites will be on the basis of need, cost, benefit derived, and number of receivers, which are being protected.

Exclusions & Limitations of the Policy

It is not the intent of this Policy to construct retrofitting noise barriers along all regional roads and identified candidate or prioritized sites. Factors such as budgetary limitations and site suitability need to be considered.

This policy is not intended to mitigate other sources of noise such as roadways under the jurisdiction of the local municipality, Provincial Highways, railways and other facilities which are not Regional infrastructure. Situations where a new regional road will be constructed adjacent to existing homes must then determine if noise abatement features are required.

If warranted, they must be incorporated into the design as part of the Class Environmental Assessment process.

The application of retrofit sound barriers along regional roads and bus transit corridors does not apply to the following:

1. Residential buildings that front directly onto a York Region facility.
2. Isolated flanking lots that are not part of a plan of subdivision.
3. Small groups of homes of less than 5 dwellings.
4. Existing residential buildings that are partially noise protected by existing inefficient and/or deficient sound barrier(s).

5. Existing development where the application of retrofit noise barriers would require construction of other additional infrastructure in order to be effective that are beyond this policy (i.e. retaining walls).
6. Where warning clauses have been included on title of purchase and residents acknowledged potential for elevated noise levels due to traffic. In these scenarios, residents have waived their rights for retrofit eligibility.

Noise Sensitive Points of Reception

1. Noise sensitive points of reception that qualify for application to the retrofit program shall meet the following criteria:
 - Residential areas adjacent to a Regional Road.
 - Reverse frontage lots or blocks including flanking units where the outdoor living areas (OLA's) are directly exposed to traffic noise.
 - Residential areas that have OLA's associated with the residential unit such as a backyard. The OLA must be clearly defined, as it will be subject to further technical analysis.
2. The following land uses with OLA's associated with them would qualify as points of reception:
 1. Single family residences
 2. Townhouses
 3. Multiple unit residential buildings; such as apartment buildings with Common OLA's. It is to be noted that the paved driveways of multiple dwelling units do not qualify.

Sound Level Criteria

The method for calculating noise levels will be in accordance with the MOE Guidelines, i.e. Ontario Road Noise Analysis Method for Environment and Transportation (ORNAMENT) Technical Document, Ontario Ministry of Environment and Energy, ISBN 0- 7729-6376, 1989 as modified by the Region to suit the local conditions and other technical adjustments prescribed by the Region.

Areas that qualify as noise-sensitive points of reception shall meet the following criteria:

- The area/site specific sound levels will be established by the Region in accordance with the technical procedures specified by the Region, as amended from time-to-time.
- The sound levels will be established based on the existing and future road and traffic parameters such as the traffic volume, percentage of trucks, posted speed limit/actual driving speed, road gradient, etc.
- The objective sound level for the retrofitting Policy is Leq daytime (7:00 a.m. to 11:00 p.m.) Leq (16hr) 60 dBA after attenuation for future traffic conditions.

- The Region will give consideration to all feasible traffic noise control measures when considering an area for noise barrier retrofitting purposes.

If a noise barrier is to be constructed as part of the retrofitting Policy, subject to the criteria and warrants in this Policy, it must achieve a minimum Insertion Loss (IL) of 6 dBA reduction when averaged over the first rows of the points of reception.

Noise Barrier Technical Criteria

The use of noise barriers as retrofitting noise mitigation measures will be subject to the following technical criteria:

1. The sound barrier must be installed on a complete block to ensure its effectiveness.
2. Retrofit noise barriers will be constructed on along the property line of the ultimate right-of-way, but within the landowner's private property. Ownership and ongoing maintenance shall be the responsibility of the homeowner. Barriers shall not interfere with easements, utilities, drainage patterns and significant/mature trees.
3. Where deemed necessary, each section of the noise barrier will be individually designed (location, height, extent, material) and cost estimates will be prepared accordingly.
4. It is the Policy of the Region to use noise barrier walls for retrofitting purposes where berms or berm/wall combinations are not feasible due to property constraints. The use of berms as a base for a noise retrofitting barrier may be considered on a case-by-case basis only; where technically warranted and where space exists for such structures.
5. The type of barrier material and color will be selected in accordance with York Region Standards and through consultation with the homeowners.
6. The cost of noise attenuation within an individual dwelling or an outdoor area that is not part of the approved points of reception will be the sole responsibility of the homeowners.
7. The minimum height of a noise barrier wall for retrofit purposes is 2.2 meters as measured from the barrier base elevation. The Commissioner of Transportation Services can approve noise attenuation barrier fences up to a maximum height of up to 3.0 meters in situations where deemed appropriate and where approved by the local municipality.

Materials for constructing noise barrier fences shall be in accordance with the materials approved by York Region and have a minimum mass surface density of 20 kg/sq.m or (4lb/sq.ft.). Noise barriers shall be constructed without cracks or gaps.

8. If required, property owners at the termination points and/or where required for the noise abatement wall will be asked to register an easement to York Region for the construction and maintenance of a noise wall along a side lot line.

Construction and Maintenance

Issues related to construction and maintenance of the retrofitting noise barriers will be subject to the following requirements:

1. The acoustic and engineering design and construction of the retrofitting noise barrier will be undertaken by the Region.

2. The design and material specifications for the wall shall be in accordance with York Region Standards and shall be discussed with the benefiting homeowners and shall also be circulated to the area municipalities for review and comment.
3. Each noise wall constructed shall be in accordance with the MOE acoustical specifications and other engineering specifications acceptable to the Region.
4. Ongoing maintenance shall be the responsibility of the homeowner.
5. Should the proposed sound barrier and other associated details be approved by the benefiting homeowners, the homeowners will be required to enter into an agreement with the Region to construct and to maintain the barrier as well as to pass the necessary By-Law as prescribed under the Act.
6. Consideration will be given by the Region to aesthetic impacts when designing noise control measures as well as the safety and security of pedestrians and motorists.

Costs and Priority

All costs associated with the retrofitting will be subject to the following requirements:

1. Requests for retrofitting will be received by the Region and will undergo initial screening and prioritization (if all warrants for construction are met) in relation to other retrofitting requests and the budget allocated by the Region for barrier retrofitting. Based on the approved funding, the cost of the approved retrofit noise mitigation will be shared equally (50/50) between York Region and the benefiting homeowners.
2. The overall cost associated with the retrofitting noise barrier, including the flanking ends, will be estimated by the Region and each owner's proportional share will be assessed (prorated) on the basis of their rear lot frontage and the flanking ends, if applicable where the sound barrier will be installed.
3. Retrofit requests will be dealt with on a case by case basis, prioritized based on this Policy, and subsequently included in the capital budget in accordance with the availability of funding.
4. The minimum number of residences to be considered for this policy is 5 dwelling units and 50 linear of noise barrier.
5. The Regional subsidy will apply to a maximum average lot width (calculated for the subject area) of 20 meters.

York Region Staff Responsibilities

All administrative and financial procedures shall conform to the Regulations under the Municipal Act.

The following are the technical responsibilities that have been assigned to York Region staff in regards to retrofitting:

1. York Region staff shall be responsible for updating the priority list or ranking for retrofitting purposes based on the most current road and traffic data.

The following are technical activities that may be carried out by or on behalf of the Region to update the priority listing:

- a) Update traffic data (AADT, speed, truck percentages, day/night split, etc.) for all road sections.
 - b) The noise prediction model to be run using the updated traffic data.
 - c) By using the noise prediction model and previously established distances, new barrier heights required to achieve 60 dBA in the Outdoor Living Areas shall be calculated and the data then entered into the priority candidate list for regional roads.
 - d) Noise barrier material costs (i.e. wood, concrete or other suitable barrier products acceptable to the Region) to be updated regularly and entered into the priority candidate list.
 - e) Other demographic data, such as the number of affected dwelling units, to be updated and entered into the priority candidate list to update the previous data.
 - f) Areas not requiring sound barriers or those not qualified for the sound barrier retrofit program to be identified and the data in the spreadsheet model to be revised accordingly.
2. Upon receipt of a petition or request for retrofitting from the public, the staff shall visit the area of concern and investigate the area for any abnormal conditions that may have been responsible for generating the noise complaints.
 3. The subject area or road sections shall visually be reviewed for technical feasibility of a retrofit barrier and also be checked against the priority list/ranking scheme and verified to warrant further consideration.
 4. Staff shall, if the subject area meets the retrofit policy warrants, prepare the necessary technical and financial details in accordance with the Regulations under the Municipal Act based on the necessary considerations including, but not limited to, the following:
 - a) Up-to-date road and traffic data
 - b) Review of alternative outdoor noise abatement features (if any exist) to meet the specified criteria.
 - c) Recommend the most effective outdoor noise abatement feature at the study site.
 - d) Ground elevations at the road, the points of reception and the base of a potential noise barrier.
 - e) Proposed noise barrier extent and location alternatives.
 - f) Possible interference, obstructions such as utilities, daylight triangles, drainage, etc.
 - g) Produce drawings to a reasonable scale showing the residential points of reception of concern, the road section, the possible location(s) of the noise barrier, etc.
 - h) Prepare detailed sound level calculations for the subject area to comply with the technical criteria of this Policy based on a minimum of one calculation for each group of three adjacent receptors, or as required.
 - i) Preparation of cost estimates for the work.
 5. For specific situations, the Region may conduct actual field monitoring of the sound levels where deemed necessary (e.g. difficult topographic situations, the presence of unusual or numerous sources of transportation sources of noise, etc). A complete package together with a summary section shall be made available to all the affected homeowners, their duly appointed representatives and the local municipality.

6. The Summary Section shall provide clear and concise information as per the Municipal Act and to also include the following:
 - a) Barrier details (extents, height, location, material, color, etc.).
 - b) The acoustic benefit to be derived including summary of the established sound levels before and after the barrier.
 - c) Estimated cost of construction (total costs)
 - d) Approximate timing of construction
 - e) Other complications, implications, site difficulties, etc.
 - f) The decision including the Region's financial share.

SCENARIO C – DEVELOPMENT PLANNING APPLICATIONS

Purpose

The purpose of this SOP is to establish noise criteria for planning of sensitive land uses, in support of the Provincial Policy Statement under the Planning Act and in accordance with the Official Plan policies of York Region. It is intended for use in planning of new noise sensitive land uses adjacent to regional roads and bus transit corridors.

The following criteria must be adhered to:

Noise Assessment Criteria

Transportation noise in general and road traffic noise in particular is a main contributor to the environmental noise climate in all urban areas.

1. Sound Levels

The daytime (Leq 16hr) outdoor sound levels from regional roads and bus transit corridors at the site of a proposed noise sensitive land use shall be established using methods acceptable to York Region and in accordance with the March 23, 2006 – York Region Council Approved Noise Policy. All other daytime (Leq 16hr) and nighttime (Leq 8hr) sound levels should be established using compatible methods generally accepted or prescribed by the local municipality or by any other approval agency. Stationary source sound levels are outside the extent of this SOP.

2. Day-time Outdoor Sound Level Criterion

The March 23, 2006 – York Region Council Approved Noise Policy provides the equivalent sound level (Leq) criterion in the designated Outdoor Living Area. The criterion applies to the entire day-time period from 07:00 to 23:00.

Noise Impact Assessment

In cases of multiple transportation noise sources such as rail and air traffic affecting a development application in proximity to a Regional Road or bus transit corridor, the following procedures shall be followed:

- a) The outdoor noise impact due to air traffic shall be established separately from the impact due to road traffic.
- b) The outdoor noise impact due to road and rail traffic shall be combined.
- c) The indoor noise impact shall be assessed separately for road, rail and aircraft noise.
- d) The required indoor noise control measures for the multiple source impact are then defined by a combined acoustical insulation parameter (descriptor) that is evaluated by combining the acoustical insulation parameters determined for each of the sources.

When predicting the sound levels, the following points shall be adhered to in the analysis and assessment:

1. Curved road sections, roads with varying grade elevations, 4 and more lane roadways and areas with multipart sound barriers/physical screening are to be assessed on the basis of multiple segments (e.g., upstream, downstream, traffic direction, localized screening).

2. Where sound barriers are involved in the analysis, calculations should be performed at more frequent locations (at every 5th dwelling unit/lot or less).
3. Reliable grade elevations at the receptors, barrier base elevations and road elevations are to be established and to be included in the study.
4. Where sound barriers are proposed, the “Acoustic Shadow Zone” cast by the noise barriers or other noise mitigation devices shall protect the OLA.
5. The higher of the posted speed limit or actual driving speed (based on the 85th percentile) shall be used in the calculation of the sound levels.
6. Where heavy truck percentages exceed 5% of the total traffic volume and where sound barrier(s) is warranted, additional and supplementary analysis shall be included in the study by separating the analysis of each vehicle class separately prior to combining the sound levels of all vehicle categories.
7. All receptors that may have an outdoor noise sensitive land use component are to be identified and addressed in the study.

In all cases, consideration should be given to future sound levels. For regional roads and bus transit corridor noise, the mature state of development road and traffic data shall be used for noise prediction purposes based on data provided (or sanctioned) by York Region.

The land proponent shall be responsible for securing any additional speed study data. Based on timing and availability, the Region can gather/provide this data upon request (extra fee may apply) that would be separate from any request for future projection traffic data.

Prediction of Road Traffic Noise

The assessment of road traffic noise impact is evaluated by prediction using statistically averaged road traffic information, normally the AADT (Annual Average Daily Traffic). The MOE prediction method for road traffic noise, recommended by York Region, is a method entitled ORNAMENT, Ontario Road Noise Analysis Method for Environment and Transportation, published in 1989. The descriptors used are the 16-hour day-time sound levels, Leq (16hr) and the 8-hour night time sound levels, Leq (8hr) for regional roads and bus transit corridors. The Region may, however, recommend the use of other enhancements and procedures to the application of the ORNAMENT.

In order to comply with the policy and other local or provincially recommended guidelines, the predicted sound level is to be assessed in an Outdoor Living Area, and at the plane of window location for indoor habitable areas. Where the noise impact exceeds the applicable criteria, warning clauses and mitigation measures such as site planning, architectural design, noise barriers, special building components and/or central air conditioning may be necessary.

No noise control measures are required if the ultimate predicted sound level estimated in the Outdoor Living Area is Leq (16hr) 55 dBA or less during the day-time and Leq (8hr) 50 dBA or less in the plane of bedroom windows during the night-time.

Application of Criteria

The noise criteria in the policy applies to the development of noise sensitive land uses affected by noise produced by vehicular traffic. Recognizing the variation of human response to transportation noise and, at the same time, the possible difficulties of implementing noise control measures in some situations, the Region may allow certain flexibility in the sound level criteria in the Outdoor Living Areas. The application and the allowable flexibility of the criteria are described below.

If the day-time sound level in the Outdoor Living Area is Leq (16hr) 55 dBA or less and the night-time level in the plane of bedroom windows is Leq (8hr) 50 dBA or less, no further assessment is required.

In case of a marginal excess over the criteria, the proponent has to demonstrate and satisfy the Region and the local municipality that it is not technically feasible to meet the Leq (16hr) 55 dBA sound level criterion. (The maximum allowable tolerance above the 16hr (day) 55 dBA is 5 dBA, which must be clearly shown and justified by the proponent). In such cases, the prospective occupants of the new land use should be notified by means of a warning clause. This clause should be included in the Agreements of Purchase and Sale, and incorporated into the relevant Development Agreements which are registered on title of the property.

Where it can be clearly demonstrated that it is not technically or economically feasible to achieve the Region's outdoor sound level criterion, a tolerance not more than 5 dBA above the stated criteria may be allowed, providing the prospective occupants of the new land use are notified by means of a warning clause. The tolerance, and the accompanying warning clause, is only allowable in conjunction with the sound levels in the Outdoor Living Area; the tolerance is not accepted for the indoor sound level criteria.

Assessment Locations

For the purposes of the noise impact assessment in an Outdoor Living Area, the protected area is approximately 56 m² (600 ft²) for single family dwellings, 46 m² (500 ft²) for semi-detached units and 37 m² (400 ft²) per unit for row housing. The local municipality shall be consulted and approve the use of smaller areas and/or certain locations for site specific applications. For the purposes of noise impact assessment in an Outdoor Living Area, the point of assessment is typically 3 meters from the building facade and 1.5 m above ground.

For the purposes of noise impact assessment in the plane of a bedroom window, the point of assessment is typically 2.5 m above ground for ground floor rooms and 4.5 m above ground for second storey rooms (or higher as appropriate for the site specific case) unless the dwelling is a multi-storey building.

The noise impact assessment in the Outdoor Living Area or in the plane of a window shall be performed in terms of a "free-field" sound level which is the sound level not affected by the presence of the building under assessment. The prediction method ORNAMENT yields the "free field" sound level.

SCENARIO D – REPLACEMENT APPLICATIONS

Purpose

The purpose of this SOP is to establish rules and responsibilities in areas of noise wall replacement where a potential safety hazard exists.

The following criteria must be established:

Noise Wall Safety Criteria

1. Potential hazards will result in the owners being directed to correct the problem within a fixed time period.
2. Failure to comply shall result in Regional staff working with Local Municipal staff to have unsafe sections dismantled and have removed materials either disposed of or stockpiled on or adjacent to the owner's property.

All costs incurred will be back charged to the homeowner with the assistance of the governing local municipality via the Property Standards Act.

MATERIAL STANDARDS & CONSTRUCTION SPECIFICATIONS

1.0 APPLICATION

The material standards and construction specifications presented herein shall be used for Capital Program Projects, Retrofit Applications, and Development Planning Applications and sound barrier replacement applications.

York Region will consider the following range of products types for noise attenuation on regional roads, these being:

1. Precast concrete panels
2. Precast concrete sections
3. Wood sound barrier walls (mostly in the form of board-on-board walls/acoustic barrier fences, refer to the appendices in these SOP's)
4. Brick veneer masonry construction
5. PVC panels
6. Recycled products
7. Steel panels
8. Natural stones
9. Composite sound barrier materials such as with the use of a combination of the above panels and in particular the variety of posts. The posts also exist in various forms.
10. Earthen berms and/or combination with above

Note: Only wooden barrier systems shall be used for capital program projects and retrofit applications.

2.0 DESIGN

The details presented in this Standard refer to noise barriers as a total and integrated system of various components including the base berm, if any, the wall, and all other associated components, as defined herein.

All individual components shall be designed to be capable of being assembled on site and to conform to the drawings and specifications. The panels to also be designed to facilitate ease of on-site replacement.

The design of the system shall be site-specific and in accordance with the latest edition of the Canadian Highway Bridge Design Code (CHBDC), prepared by qualified Professional Engineers and Acoustic Consultants. Input will be required from Geotechnical and/or Structural Engineers.

The noise barrier shall be designed to withstand all possible forces and loads encountered during the design life of the barrier and remain serviceable. The design shall be site specific with reference to the wind pressure, earthquake load, freezing depth and soil conditions.

The foundation of the barrier wall shall be designed to be founded on undisturbed soil, and at required depth of embedment as per the design requirements, but not less than the depth of freezing of the area.

3.0 ACOUSTICS

3.1 MATERIAL DENSITY/SOUND TRANSMISSION CLASS (STC) REQUIREMENTS

For a panel to be qualified as a sound barrier material, one or more of the following conditions should be met:

- The surface density of the panel material to be not less than 20 kg/sq.m.
- The Sound Transmission Class (STC) of the panel material to be 20, or greater, when tested in accordance with ASTM-E90 (a test report to be submitted for approval).
- The Sound Transmission Class (STC) of the panel material has historically been demonstrated to be 30 or greater.

In addition, sufficient measures are to be taken to prevent drumming of the panels caused by wind or ground vibration.

3.2 NOISE REDUCTION COEFFICIENT (NRC)

If the noise barrier system is specified by the Acoustical Consultant to be sound absorptive, the barrier panels should be tested to determine the Noise Reduction Coefficient (NRC) in accordance with ASTM-C423. A panel or an assembly of panels should be tested, as required, in accordance with the ASTM Procedures for free-standing screens.

The use of alternate methods of providing the necessary sound absorptive qualities by a barrier system should be subject to special approval by the Region based on qualified technical data to be submitted by the proponent. This may include the use of double walled noise barrier panels (sandwich construction with perforated facing) or the use of substantial landscaping designs along the barrier faces by a Landscape Architect.

3.3 EXPANSION JOINTS

The noise barrier is to be designed and installed so as to accommodate movement of the noise barrier panel during the weather cycle without placing undue stress on any structure and the noise barrier installation, or reducing acoustical attenuation. The joints in the noise barrier are to match the size and location of the structure joints.

3.4 HEIGHT

The noise barrier system design should provide details of methods and materials to be used to accommodate varying wall heights above the top of footing.

3.5 PANEL ORIENTATION

Noise barrier elements should be designed and oriented to minimize entrapment and ponding of water, and accumulation and infiltration of dirt and debris inside and on any surface of any component. Corrugated, or ribbed panels, should be mounted such that the features are oriented vertically.

3.6 PANELS WITH FIRE HOSE ACCESS

Noise barrier panels with fire hose access openings, if required, shall be designed with additional reinforcement and protective coating around the opening, as necessary, to maintain structural integrity.

4.0 MATERIALS

4.1 GENERAL

For materials, not specifically included in this section, the manufacturer should demonstrate to the Region that the material has a minimum predicted maintenance free lifespan of 20 years.

All materials should have a flame spread classification less than, or equal to, 140 and smoke developed classification less than, or equal to, 180 when tested in accordance with the ULC standards.

Metal and non-metallic components of noise barrier systems, including their performance, such as corrosion and weathering, to be in accordance with the applicable CSA, ASTM, CAN/L1LC, ULC, CSA/CAN and ANSI standards.

4.2 COATINGS

Coatings refer to all paints, stains and laminates. All coated components to be rated for accelerated weathering. All coated steel components to be resistant to corrosion.

Components which are hot dip galvanized, or coated with a polyvinyl chloride (PVC) plastisol using an epoxy primer using no adhesives for bonding, need not have accelerated weathering test data

4.3 CONCRETE PANELS AND POSTS

4.3.1 CAST-IN-PLACE

Cast-in-place concrete to conform to the requirements of the CSA Standards.

4.3.2 PRECAST

Precast concrete to conform to the requirements of the CSA Standards.

4.4 STEEL REINFORCING

All steel reinforcing to conform to the requirements of the CSA Standards. The bars to be free from rust, scale, or other substances, that will prevent bonding.

All reinforcing bars should be epoxy coated, conforming to ASTM Standards. The concrete cover over the steel reinforcing should meet the requirements of the CSA Standards and in no case should it be less than 50mm.

4.5 BARE METAL COMPONENTS

All bare metal components to be either fabricated of nonferrous materials or hot dip galvanized after fabrication, according to the requirements of CSA Standards. All welding to conform to CSA Standards.

4.6 COMPOSITES AND METAL PANELS

Steel panels, exposed to traffic and snow removal operations, to be minimum nominal 0.91 mm galvanized steel (20 gauge). All other panels to be of minimum nominal 0.76 mm galvanized steel (22 gauge). All steel sheeting components to be coated with a material meeting the requirements of this standard.

Acceptable products include galvanized panels and then coated with an organic polyvinyl chloride (PVC) plastisol using an epoxy primer using no adhesives for bonding. The coating system thickness must be 200 um on the surfaces exposed to traffic and snow removal operations and 100 um thick on all other panel surfaces.

Pop-rivets shall be either aluminum, with an aluminum mandrel, or aluminum, with a stainless steel mandrel.

Other composites or metal panels, such as aluminum, may be used as panels for sound barriers, provided that such products are corrosion resistant and meet the acoustic and other performance criteria in this Standard.

4.7 SOUND ABSORPTIVE QUALITY

If the noise barrier system is specified by the Acoustical Consultant to be sound absorptive, the average Noise Reduction Coefficient (NRC) shall be not less than 0.70 (70%). Sound absorptive materials used to fill cavities in double walled noise barrier systems, to increase sound absorption, shall be semi-rigid type.

4.8 WOOD COMPONENTS

All wood products to be made out of graded lumber (conforming to National Lumber Grading Association or Standard Grading Rules of Canadian Lumber 2000) and to be either naturally resistant to decay for a minimum of 20 years, or to be pressure treated. The panel must be composed of tightly fitted wood boards so as to avoid warping, splitting and loosening of particles, knots and imperfections. All boards must be tightly butted and secured.

The use of board-on-board panels to meet the stated density/acoustic criteria is acceptable provided that the boards are thoroughly secured. In addition, board-on-board panels shall have tightly butted joints that are staggered, with provision to allow for expansion/contraction, and for making the necessary field adjustments (e.g. for tightening up of developed gaps), where required.

The use of Tongue and Groove, and V-joints for joining panels is acceptable provided that the tongue or V-joint extent is not less than 19mm (3/4") long.

Nails, and other fastening devices, must be either hot dip galvanized steel, or made of nonferrous or stainless steel.

When there is ground contact with wood, the wood must be pressure treated and cut ends to be treated also, or protected from moisture penetration.

For wooden noise barriers, the following are the minimum acceptable features to qualify as an acceptable noise barrier system:

1. All wood shall be selected for good appearance and free of defects and large/heavy knots. In addition, all torn grain and surface stains shall be eliminated by appropriate surface refinishing.
2. All skirts, coming in contact with the ground/soil, shall be pressure treated with finished cut edges treated or protected from moisture penetration, and to be buried 100 to 150mm below the finished ground level.
3. All exposed panels to be dressed with beveled edges on both sides.
4. All wooden posts (metal posts are also acceptable) to have minimum dimensions of 140 x 140mm, or larger, as required by the governing code, dressed to pattern.
5. Double posts are required on all directional changes greater than 20°.
6. Install coping on top of panels using one piece wood (or other acceptable metal products)
7. The use of decorative elements such as pilasters, curved (scalloped) top rail, post caps, wood designs, etc. is preferable. In all cases, the decorative elements should not affect the minimum barrier height requirements, the density, or any other acoustic/structural requirements.
8. Wood, and/or metal frames, to be used to support the wood panels in place, and to be designed to allow expansion/contraction of the wood panels/elements, and for making the necessary field adjustments, where required.
9. All metal components, if any, used in a wooden sound barrier to conform to the metal or steel component specifications in this Standard.

4.9 BRICK

All bricks used to be in accordance with the CSA standards.

4.10 GRANULAR MATERIAL

All granular materials shall be free from deleterious materials, debris and organic materials. When used, it shall be compacted to 98% of Standard Proctor Dry Density.

5.0 INSTALLATION AND CONSTRUCTION

All work and noise barrier materials for specific installations are subject to field certification by the design professionals to ensure adherence to the requirements in this specification.

All materials delivered to the construction site should be visually inspected by the owner, and/or their representative, for proper dimensions, cracks, voids, surface defects, inconsistency in color and texture, and any other damage or imperfections.

5.1 HEIGHT AND ALIGNMENT

The noise barrier shall be constructed to the height and alignment as specified on the standard drawings at the end of this document.

5.2 FOOTINGS, POSTS AND PANELS

The foundation, footing and post design, shall meet the objective of constructing a durable sound barrier that meets or exceeds the objectives of this Standard of a 20-year life expectancy and the set minimum guarantee of 5 years for material and installation of the noise barrier system.

5.2.1 FOOTINGS

The footing shall be founded on undisturbed soil at the design embedment length as required but shall be minimum below freezing depth of the area. The founding surface shall be confirmed by a Geotechnical Engineer. All the soft spots to be removed and bottom of the footing protected from freezing. In case of solid rock encountered at a depth less than the freezing depth, foundation shall be carried minimum 300mm in the rock. The concrete of footing shall be as follows:

1. Minimum 28 days compressive strength to be 20 Mpa
2. Ready mix concrete or site mix concrete to confirm to CSA-A23.2
3. All site placed concrete to be protected from freezing and to be protected in excessive summer temperature from drying.
4. The concrete in the footing shall be cured for a minimum period of 5 days before the installation of panels.

5.2.2 FOOTINGS IN EARTH

If drilled footing is used, it shall be cast entirely against undisturbed soil. Footing other than drilled caisson to be formed and the excavation shall be backfilled with granular material. The backfilled material to be compacted to 98% Standard Proctor Dry Density of the granular material.

5.2.3 FOOTINGS IN ROCK

When rock is encountered within the excavation depth of the footing, the footing depth to be embedded minimum 300 mm into the solid rock.

All excavation into rock shall be back filled entirely with concrete. The excavation above the top of rock may be formed to the required dimensions and the remainder of the excavation backfilled with granular materials.

5.3 POSTS

The barrier shall be constructed to the line and grades specified with the tolerance of ± 10 mm. The post shall be plumb within a tolerance of ± 10 mm in 5m. In all cases for wood posts, the minimum dimension shall be 150mm square.

5.4 PANELS

The profile of the barrier shall be installed to match the ground profile up to the maximum grade specified on the drawings. To accommodate ground profiles greater than the maximum grade, the barrier shall be stepped in accordance with manufacturer's recommendations.

5.5 SITE GRADING AND PREPARATION

Earth grading and berm construction associated with the barrier installation shall be completed to within 25mm of the proposed elevation of the bottom of the barrier. Grading shall be completed and approved prior to construction of the barrier footings.

To prevent openings from occurring under the barrier an additional timber, not less than 5mm x 20mm in section, shall be securely fastened horizontally to the bottom of the barrier, and shall extend the full width of each barrier panel between adjacent vertical posts. This additional timber shall be buried to a depth equal to one-half its width during the final grading operation. Earth and pavement grading shall be sloped at a minimum of 2% and a maximum of 50% away from the barrier.

Frozen earth shall not be used for embankments. Where imported fill is required for backfill or for minor grading, the fill material should be comprised of granular material, select sub-grade material, or other approved fill and to be compacted to at least 98% Standard Proctor Maximum Dry Density (SPMDD). All graded earth to be compacted to at least 98% Standard Proctor Dry Density.

The earth area surrounding the barrier wall shall be sloped away in order to prevent water ponding and water filtration to the barrier footings.

Changes in alignment to occur at the posts, by suitable means, to avoid acoustical degradation.

5.6 MASONRY WALLS

Masonry walls to be installed in accordance with the requirements of AASHTO Guide Specifications for Structural Design of Sound Barriers.

Bricks to be installed on a suitable foundation not less than 500 mm above the final ground line.

The top row of all masonry walls and posts to be protected with coping and/or flashing.

Mortar used to set the bricks, shall be in accordance with the CSA Standards.

5.7 FIRE HYDRANT ACCESS

When the installation of a noise barrier interferes with the access to existing, or proposed fire hydrants, the noise barrier installation should include fire hose access openings and associated identification signs. Location and demand for these openings to be established in cooperation with the local fire department.

5.8 OVERHEAD HIGH VOLTAGE LINES

Where the potential of arcing exists, due to the close proximity of existing overhead high voltage lines, each metal panel and girt must be grounded in accordance with CSA Standards and the local hydro / utility company.

6.0 OTHER CONSIDERATIONS

6.1 AESTHETICS

The design of noise barriers should also have regard for the following:

1. The applicable urban design guidelines and landscaping requirements.
2. Drainage, grading, landscaping design and aesthetic principles.
3. The design of the barrier should be complimentary with nearby existing barriers.

6.2 LANDSCAPING

Soft landscaping, that could include trees and vines, to be included in all barrier projects.

6.3 RESONANCE (DRUMMING EFFECT)

To avoid excessive resonance by certain noise barrier wall materials, such as metal panels, the barrier system to be designed to reduce this phenomenon by acceptable means such as the use of additional stiffeners, the application of noise damping compounds, sandwich construction, etc.

7.0 APPROVAL BY THE REGION

7.1 NOISE BARRIER SYSTEM

In order for the noise barrier system design, and materials, to be qualified and be considered for approval, for installation at a specific site, the submission should provide the following:

- a) The trade name of the product, if applicable.
- b) The manufacturer's name and address.
- c) Certification by a Geotechnical Engineer (calculations may be requested).
- d) Certification by a Structural Engineer (calculations may be requested).
- e) Detailed drawings of the entire noise barrier system and all its components.
- f) A general statement as to the composition of the materials.
- g) Specifications regarding installation requirements as well as sequence of construction:
- h) Noise Reduction Coefficient (NRC) report if the noise barrier is to be considered as sound absorptive; if required by the noise study.
- i) Sound Transmission Class (STC) and/or the material surface density.
- j) Detailed material specifications.
- k) Warranty.

Any new design, material or installation technique for a noise barrier system will be evaluated for acceptability of use in the Region with a view to safety, durability, functionality and cost effectiveness.

The design drawings and calculations shall be signed, sealed and dated by Professional Engineer(s) licensed in the area of expertise for which the approval is being sought.

7.2 LIST OF APPROVED SUPPLIERS

Noise Barrier Company	Primary Noise Barrier Material, System, Finish...	Address	Phone Number
Prestige Fence	Steel frame system with wood infill panels (white pine)	163 Cardevco Road R.R. #2 Carp ON K0A 1L0	613-831-2073 and /or 888-676-3325
Central PreCast Inc.	Precast concrete panels with reflective or absorptive finishes	25 Bongard Avenue Nepean ON K2E 6V2	613-225-9510
Alcuf International Inc	Aluminium frame system with a variety of infill panel materials including wood, steel composites and proprietary boards	5350 Canotek Road Unit 20 Gloucester ON K1J 9E2	613-749-9393
International Fence Limited	Precast concrete panels (Vertarib 200) smooth finish or broom finish	541 Piercey Road Bolton ON L7E 5B5	905-951-7337
Durisol	Composite concrete/wood chip panels and steel frames	505 York Blvd., Suite 2 Hamilton ON L8R 3K4	905-521-0999
Homeland Vinyl Fencing Ltd	Composite PVC (Vinyl), wood or steel posts	75 Stafford Drive Brampton, ON L6W 1L3	905-790-3400
Compact Industries	Primarily wood with wood or steel posts	25 Sheffeld Street North York ON M6M 3E5	416-249-7921
Roma Fence	Primarily wood with wood or steel posts	24 Cadetta Road Brampton ON L6P 0X4	416-798-7566
Bramalea Fence Limited	Aluminium frame system with a variety of infill panel materials including wood, steel composites and proprietary boards	75 Stafford Drive Brampton ON L6W 1L3	905-453-1373
AIL Sound Walls	Synthetic wall system with absorptive or reflective panels. Optional embossed finish	640 Waydom Drive Ayr ON N0B 1E0	866-231-7867

The Region will periodically review and update this list of approved suppliers of noise barrier systems by Region of York staff. Should a supplier wish to be placed on this list, please contact the Roads Branch of the Transportation Services Department for an opportunity to discuss the proposed barrier system.

8.0 INSTALLATION

This section deals with the installation of noise barriers, including design, submission, approval, construction and completion of the contracted work.

The following subsections briefly describe the minimum required data, and specifications, to be completed by the proponent in order to obtain approval from the Region:

9.0 SUBMITTALS

The following documents shall be submitted to the Region for approval for each noise barrier wall project:

- a) Shop drawings, signed and sealed by a qualified Professional Engineer licensed by the Professional Engineers of Ontario, showing the details of noise barrier system components, including material specifications.
- b) Structural drawing(s), signed and sealed by a qualified Professional Engineer licensed by the Professional Engineers of Ontario, showing foundation details and specifying design criteria, climatic design loads, as well as applicable geotechnical data used in the design.
- c) Layout plan, and wall elevations, showing proposed colours and patterns.
- d) A covering letter stating deviations or exceptions to the Region Standard and the reasons/justification for the deviations.

10.0 SITE PREPARATION AND GRADING

To be completed by the proponent.

11.0 FOUNDATIONS

To be completed by the proponent.

12.0 DELIVERY, HANDLING, STORAGE AND PROTECTION

To be completed by the proponent.

13.0 ERECTION / INSTALLATION OF NOISE BARRIER

To be completed by the proponent.

14.0 CLEAN UP

To be completed by the proponent.

15.0 TESTING, INSPECTION AND QUALITY ASSURANCE

To be completed by the proponent.

16.0 INITIAL CERTIFICATION AND PERFORMANCE ACCEPTANCE

An Initial Certification by the proponent's Project Engineer to be prepared and submitted to the Region following completion of the project.

17.0 GUARANTEE AND MAINTENANCE PERIOD

- The noise barrier system (material and installation) to be guaranteed for a minimum period of five (5) years from the date of the initial Certification and Performance Acceptance. A Letter of Credit in the amount of 15% of the sound barrier total cost shall be deposited with the Region to cover the warranty.

- After 3 years from Certification, an inspection is to be carried out by the proponent's Engineer with a report to be submitted to the Region. Any components which exhibit defects that are likely to affect the longevity of the barrier shall be replaced and/or repaired.
- To obtain release of the noted Letter of Credit, a final un-conditional warranty inspection shall be prepared by the proponent's Engineer after five (5) years from the date of original Initial Certification and Performance Acceptance of the barrier to certify that there are no deficiencies of any component of the barrier system; examples include grading, berm, posts, panels and soil condition.

Standard Operation Procedures Supplement Document: Case Scenario Guidelines – Noise Sensitive Uses (For use with Capital Road Projects Section only)	
N.01	Schools, Churches, Day Cares, Hotels
	<p>The Region does not normally provide mitigation for these uses alone. Although such uses can still be considered noise sensitive due to the incorporation of other indoor spaces that may differ from typical residential living or sleeping quarters in a dwelling unit; these properties shall still be reviewed by the acoustic consultant during the EA to confirm if any OLA's may be associated with any specific habitable uses within these properties.</p> <p>For example, where a property such as an educational institution has functions for housing or lodging accommodations, then an associated outdoor amenity, where provided, should be considered an OLA if the amenity is intended for the quiet enjoyment of the outdoor environment; and meets the full definition of OLA.</p> <p>In such cases, the acoustic consultant shall review and determine if the amenity is intended for use as a quiet space or other recreation/ancillary use. Only after such a review should a recommendation be made to determine if the property is eligible for any mitigation.</p>
N.02	Inhabited or Abandoned Properties
	<p>The Region will continue to study and assess new mitigation for these properties when warranted as part of the EA. The Region will defer the final decision to implement mitigation in these areas based on further review at detailed design and/or construction.</p> <p>The acoustic consultant shall identify in the report all properties that are abandoned or appear to be in an inhabited state; and include a note that implementation of the specific noise barrier will be subject to the approval of York Region.</p>
N.03	Modified or Reconstructed Homes
	<p>The acoustic consultant shall consider only the existing building location and outdoor amenity area at the time of preparing the noise study. Any changes to the dwelling or property by the homeowner during the EA and after the site investigations have been completed will not be reconsidered as part of the current study.</p> <p>Additionally, approved site plans (or studies) for other future developments shall be reviewed as part of preparing the EA noise assessment.</p>

**Standard Operation Procedures Supplement Document:
Case Scenario Guidelines – Land Compatibility
(For use with Capital Road Projects Section only)**

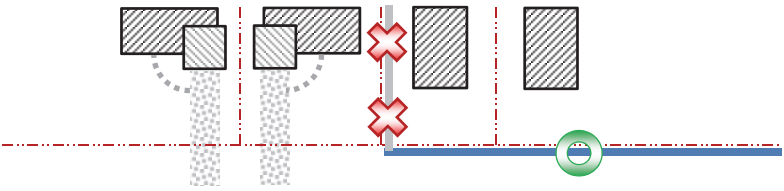
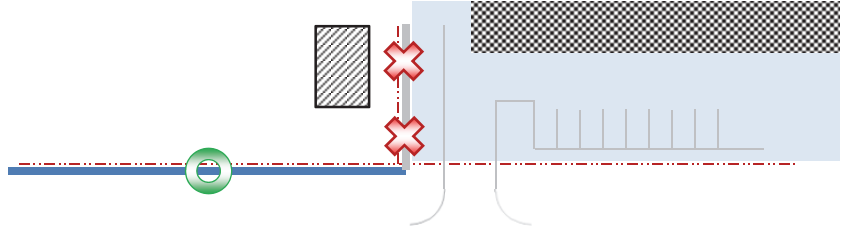
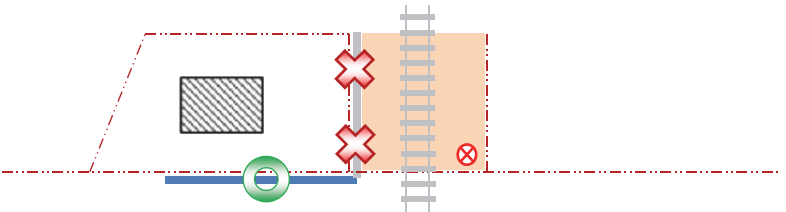
L.01	Barriers Near Opposing Residential Frontages
	<p>The Region will not provide noise barrier fence returns on (or between) private property.</p>  <p>Side returns on residential property are not permitted.</p>
L.02	Barriers Near Commercial Areas
	<p>The Region will not provide noise barrier fence returns on (or between) private property.</p>  <p>Side returns on commercial property are not permitted.</p>
L.03	Barriers Near Rail Corridors
	<p>The Region will not provide noise barrier fence returns on (or between) private / rail property.</p>  <p>Side returns on rail property lands are not permitted.</p>

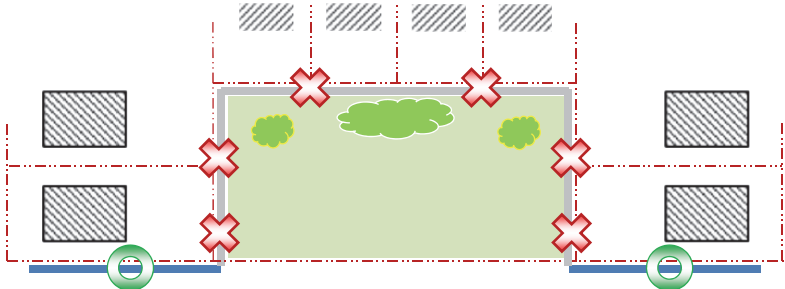
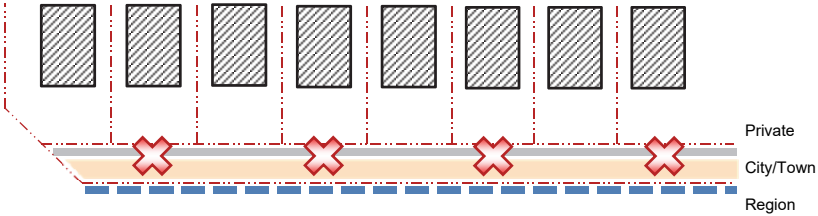
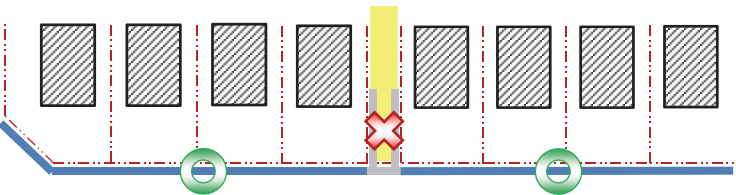

**Standard Operation Procedures Supplement Document:
Case Scenario Guidelines – Land Compatibility
(For use with Capital Road Projects Section only)**

L.04	Barriers Near Local Parks
	<p>The Region shall avoid placing noise barrier fences on (or between) private / municipal park property.</p>  <p>Side returns and fences on local municipal park property shall be avoided.</p>
L.05	Barriers Near Other Municipal Land Buffers
	<p>The Region shall avoid placing noise barrier fences on intervening buffer lands that may be owned by <u>other</u> public agencies, unless use of the land has been granted for the project.</p>  <p>Noise barriers will not be normally installed on the right-of-way where intervening lands exist. The Consultant shall review in detail and clearly document the ownership of all lands bordering the right-of-way as part of their mitigation recommendations.</p>
L.06	Barriers Near Public Walkways and Accessible Openings
	<p>The Region will not provide noise barrier fence returns on (or between) private / local municipal property; or obstruct any required opening.</p>  <p>Side returns on local municipal property (e.g. walkways) are not permitted. The Consultant shall review in detail and clearly document any necessary openings along the noise barrier.</p>

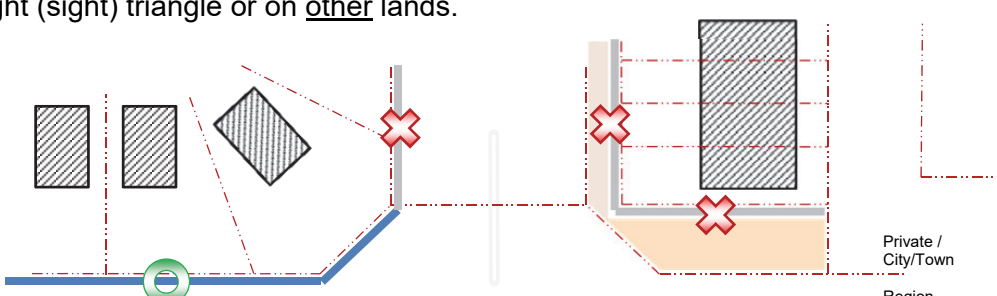
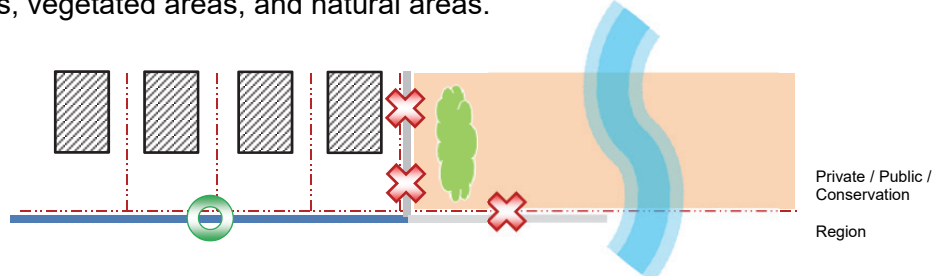
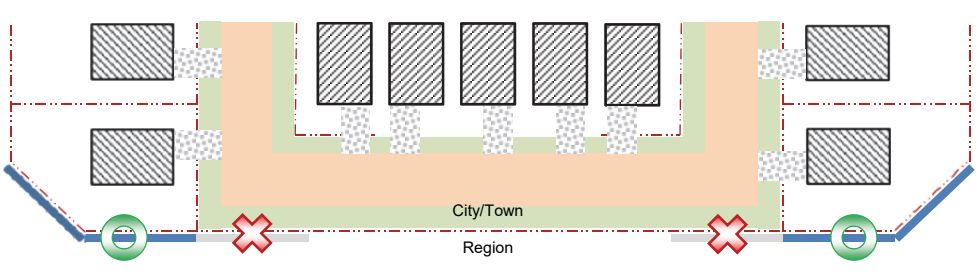
**Standard Operation Procedures Supplement Document:
Case Scenario Guidelines – Land Compatibility
(For use with Capital Road Projects Section only)**

L.07	Barriers Near Daylight Triangles
	<p>The Region shall avoid placing noise fence returns beyond the normal Regional daylight (sight) triangle or on <u>other</u> lands.</p>  <p>Noise barriers on lands other than the Region's shall be avoided near daylight triangles. The Consultant shall review in detail and clearly document the ownership of all lands bordering the right-of-way as part of their mitigation recommendations.</p>
L.08	Barriers Near Open or Protected Areas
	<p>The Region will not provide noise barrier fence returns on (or between) private / open areas; and shall avoid obstructing any open space. These may include areas such as vacant lands, vegetated areas, and natural areas.</p>  <p>Noise barriers along or on open lands are not permitted.</p>
L.09	Barriers Near Window Streets
	<p>The Region will not provide noise barrier fences on (or between) a local municipal road; and shall avoid obstructing any open public space.</p>  <p>Noise barriers along adjacent local municipal roads are not permitted.</p>

**Standard Operation Procedures Supplement Document:
Case Scenario Guidelines – Community Integration
(For use with Capital Road Projects Section only)**

C.01	Barrier Extension Across Unwarranted Residential Properties
	<p>This situation describes the outer end treatment of a noise barrier alignment along a row of contiguous homes (excluding frontage properties).</p>  <p>A noise barrier may be permitted to extend across from behind a warranted property (e.g. meeting criteria), over to behind a neighbouring property that may not have warranted mitigation (e.g. below criteria), in order to meet the required barrier effectiveness (e.g. minimum 6 dB) at the prime warranted location(s). The extended length (e.g. extra barrier section needed) should be designed in a local context sensitive manner.</p> <p>Where the situation may exist, the consultant should provide details supporting the extensions along with any context sensitive design considerations.</p> <p>These locations should be reviewed on a case-by-case basis with the Region’s Project Manager.</p>
C.02	Barrier Infilled Across Unwarranted/Ineffective Residential Properties
	<p>This situation describes the middle (or inner) treatment of a noise barrier alignment along a row of contiguous homes (excluding frontage properties).</p>  <p>In such situations, a practical solution is preferred where small or sporadic gaps along a barrier would be undesirable due to adversely affecting the overall effectiveness of the noise barrier. However, due to varying local conditions, the Consultant shall review the barrier design in a local context sensitive manner.</p> <p>A noise barrier may be permitted to be infilled between discontinuous warranted properties (e.g. meeting criteria), covering one or more inner properties that may not have warranted mitigation (e.g. below criteria) or may not have been effectively mitigated (e.g. less than 6 dB).</p> <p>The evaluation between providing an infilled noise barrier or segmenting the noise barrier should be reviewed in a local context sensitive manner. The Consultant should provide a clear and preferred recommendation for either infilling the noise barrier or segmenting the noise barrier, and weigh the design alternatives (acoustically and non-acoustically).</p> <p>Where the situation may exist, the consultant should provide details supporting the infilled or segmented sections along with any context sensitive design considerations.</p>

**Standard Operation Procedures Supplement Document:
Case Scenario Guidelines – Community Integration
(For use with Capital Road Projects Section only)**

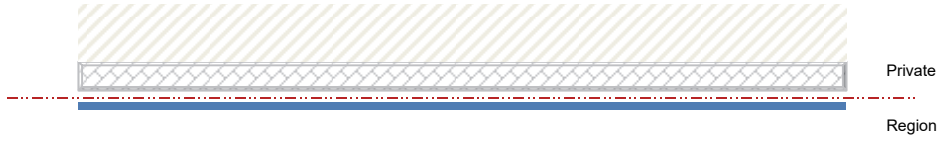
	These locations should be reviewed on a case-by-case basis with the Region's Project Manager.
C.03	Subdivision Entrance/Architectural Features
	<p>Regional noise barriers should be designed to be context sensitive with existing entrance features that may require modification as a result of integrating the Region's noise barrier design. Noise mitigation should be designed to be effective while efforts should be made to preserve the original subdivision design or gateway feature. In constrained areas where the two join, the noise mitigation effectiveness may be reduced.</p> <p>The consultant should identify subdivision entrance features that could be potentially impacted where Regional noise mitigation is proposed.</p>
C.04	Existing Private Retaining Walls
	<p>New noise barriers may be permitted opposite to (e.g. beside) existing private retaining walls where the Regional noise fence can be located at the edge of the Region's right-of-way.</p>  <p>Where mitigation is warranted due to the proposed road works, the evaluation of the noise fence height should be measured on the road-side grade, not including the private retaining wall.</p> <p>The consultant shall clearly identify the proposed noise barrier locations as well as the adjacent existing private retaining wall locations; and identify any potential impacts or construction hurdles (on either side) as part of implementation.</p> <p>The implementation feasibility of constructing the noise barrier should be considered again during detailed design. The construction of noise mitigation may be subject to the implementation feasibility around the surrounding uses.</p>

**Standard Operation Procedures Supplement Document:
Case Scenario Guidelines – Community Integration
(For use with Capital Road Projects Section only)**

C.05 Existing and Proposed Regional Retaining Walls

New noise barriers may be permitted on Region owned & maintained retaining walls where the Regional noise fence can be located within the Region's right-of-way.



Where mitigation is warranted due to the proposed road works, the evaluation of the noise fence height should be measured from the top of the existing or proposed retaining wall.

The feasibility of constructing the overall structure should be considered again during detailed design. The construction of noise mitigation may be subject to the feasibility and/or extent of retrofitting the existing retaining wall and accommodating surrounding uses.



TRANSPORTATION SERVICES

STANDARD DRAWINGS FOR WOODEN NOISE BARRIERS ON YORK REGIONAL ROADS



TRANSPORTATION SERVICES

INDEX

STANDARD NOISE BARRIER LOCATION	SHEET A
WOOD NOISE BARRIER ELEVATION - FLAT GRADE INSTALLATION	SHEET B1
WOOD NOISE BARRIER ELEVATION - SLOPING GRADE INSTALLATION	SHEET B2
POST AND BASE CONSTRUCTION DETAIL	SHEET C
POST, RAIL, COPING & CONSTRUCTION FASTENING DETAIL	SHEET D
POST AND POST CAPPING DETAIL	SHEET E
EXPLODED VIEW - BOARD ON BOARD FASTENING DETAIL	SHEET F
MATERIAL AND FINISHING DETAIL	SHEET G
AESTHETIC ENHANCEMENTS	SHEET H

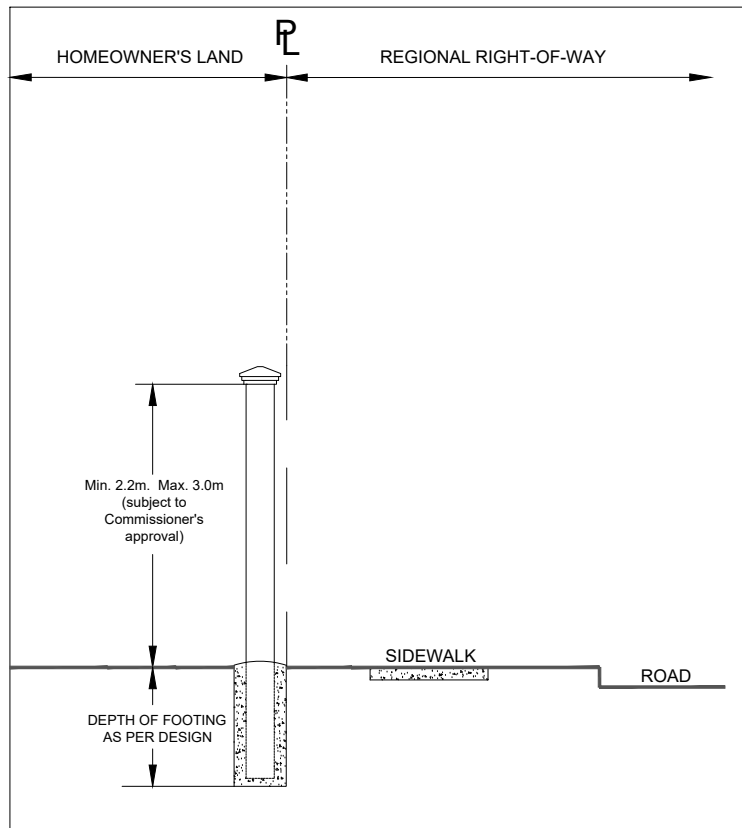

DEVELOPMENT & RETROFIT LOCATION

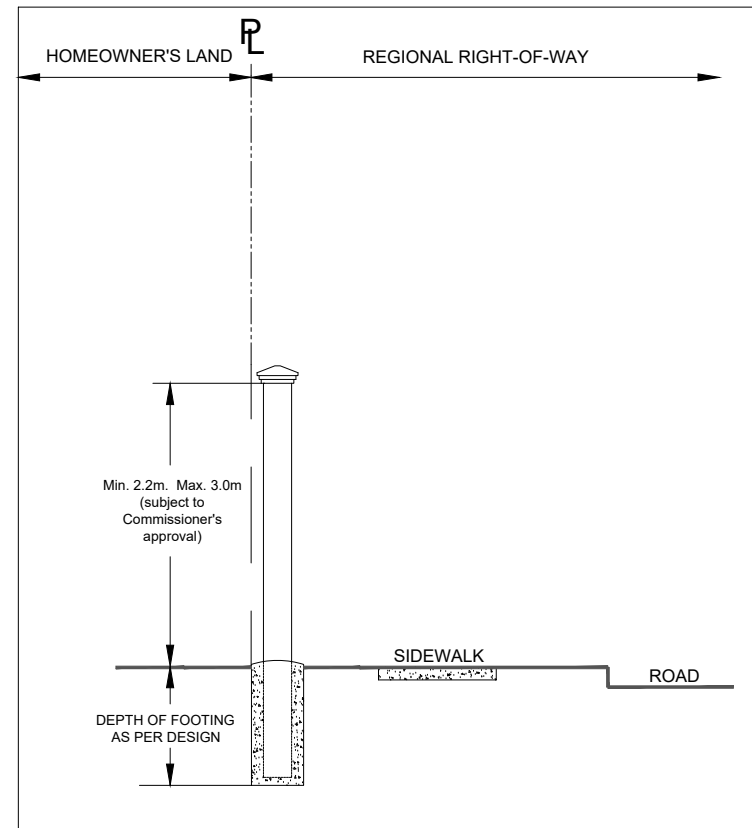

CAPITAL PROGRAM LOCATION

DESIGN DETAILS:

1. Barrier materials shall be in accordance with the materials approved by York Region.
2. Boulevard grades to be revised to suit the ultimate edge of pavement grades.
4. Positive drainage must be maintained away from the wall at all times.
5. Structural design (footing and posts) must meet wind pressures as per the Canadian Highway Bridge Design code (latest version) and be stamped by a Professional Engineer.



**Transportation
Services**

SHEET A
STANDARD NOISE BARRIER LOCATION

November 2019

DATE

FOR FENCE MATERIAL AND FINISHING TREATMENTS REFER TO SHEET G

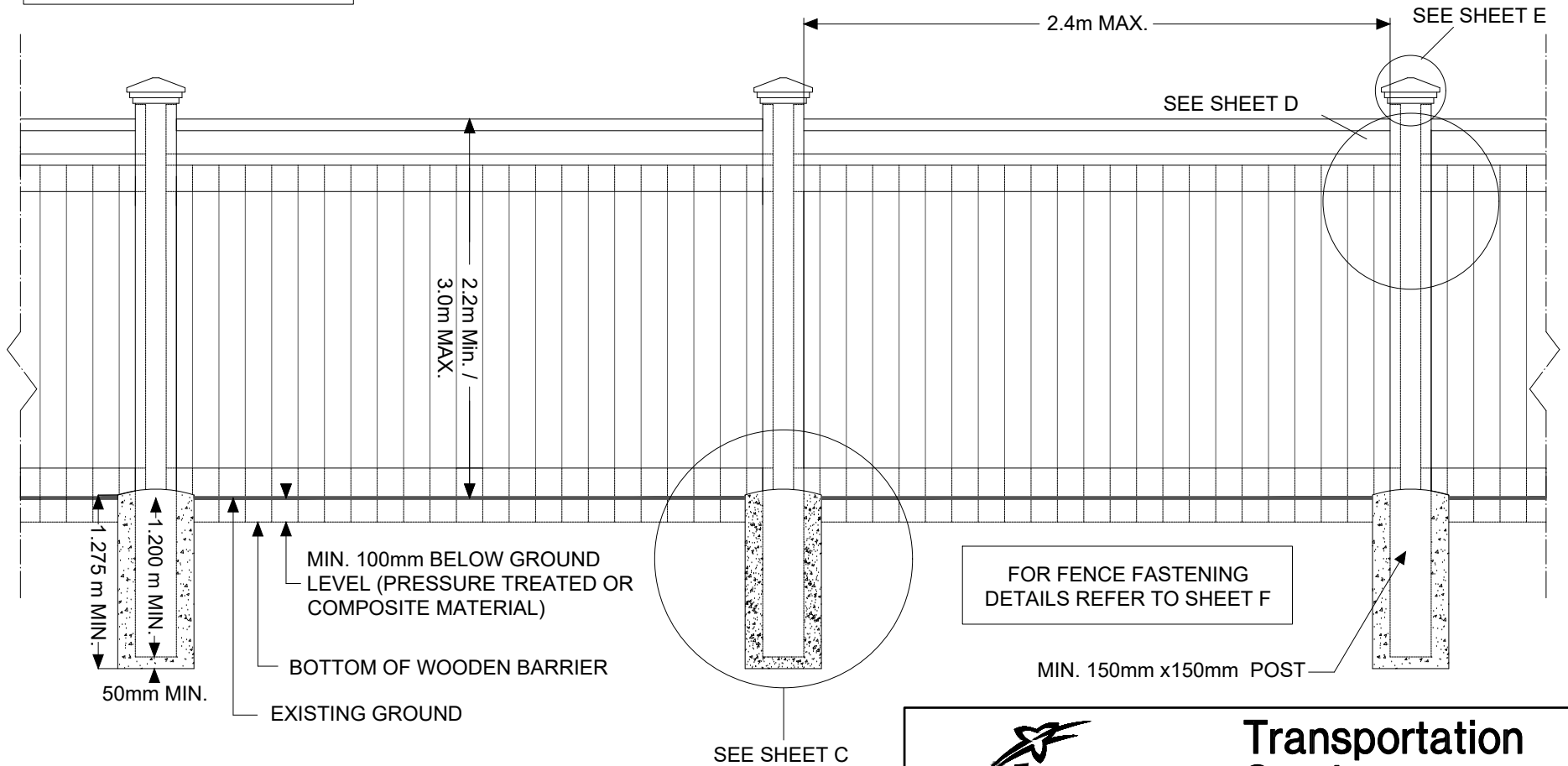

Notes:

1. All wood shall be selected for good appearance and be free of defects and large/heavy knots.
2. Barrier materials shall be in accordance with the materials approved by York Region.
3. All torn grain and surface stains shall be eliminated by appropriate surface refinishing.
4. Maximum height of noise barrier is 3.0 metres. (Commissioner of Transportation Services must approve noise attenuation fences over 2.7 metres where deemed appropriate.)
5. Posts shall be plumb within 5mm/m above grade.
6. For fence fastening details refer to sheet F.
7. For fence material and finishing treatments refer to sheet G.
8. For aesthetic treatments, refer to Sheet H.



Transportation Services

SHEET B1

WOOD NOISE BARRIER ELEVATION -
FLAT GRADE INSTALLATION

November 2019

DATE

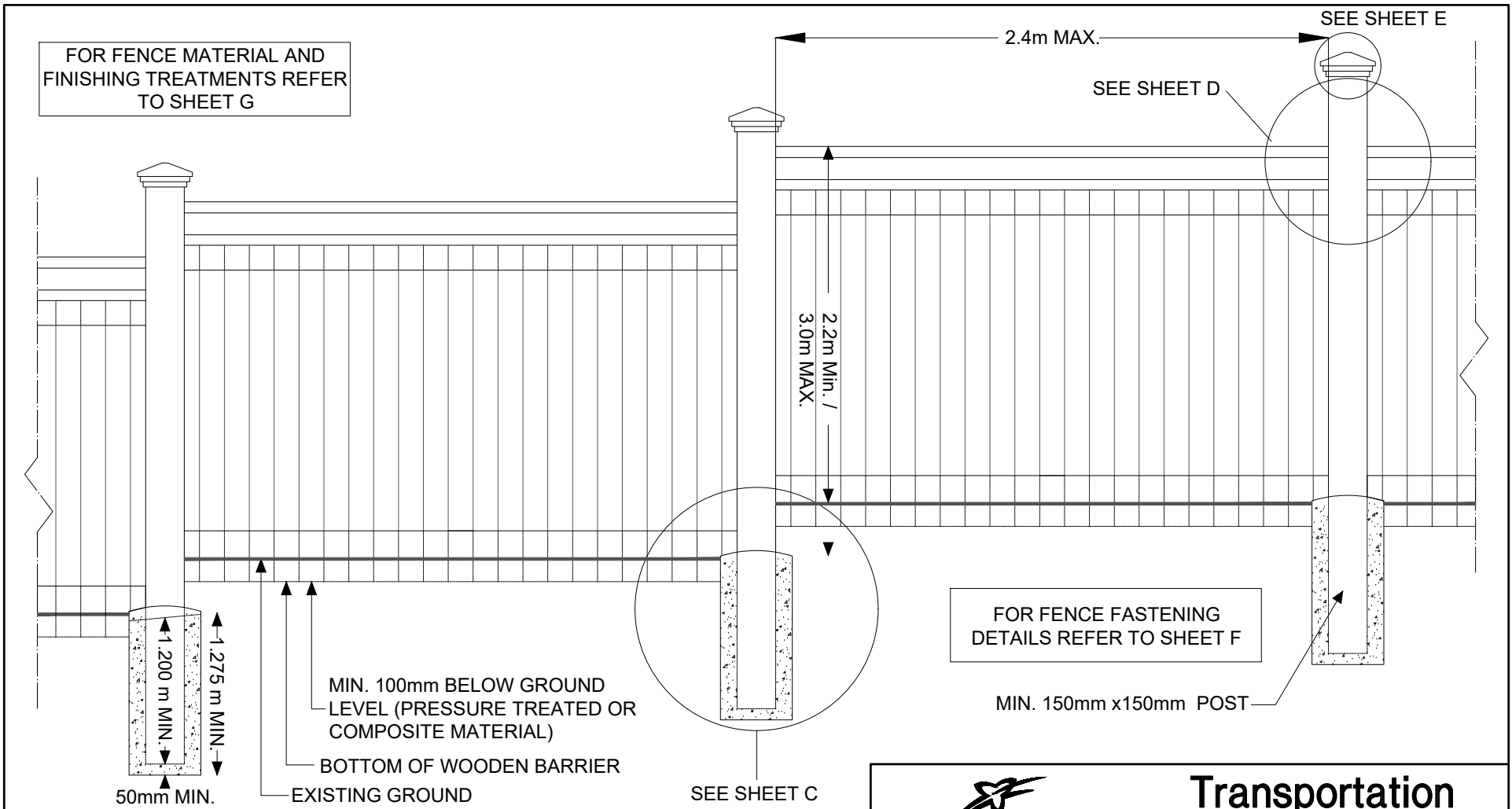

Notes:

1. All wood shall be selected for good appearance and be free of defects and large/heavy knots.
2. Barrier materials shall be in accordance with the materials approved by York Region.
3. All torn grain and surface stains shall be eliminated by appropriate surface refinishing.
4. Maximum height of noise barrier is 3.0 metres. (Commissioner of Transportation Services must approve noise attenuation fences over 2.7 metres where deemed appropriate.)
5. Posts shall be plumb within 5mm/m above grade.
6. For fence fastening details refer to sheet F.
7. For fence material and finishing treatments refer to sheet G.
8. For aesthetic treatments, refer to Sheet H.

	<h1 style="margin: 0;">Transportation Services</h1>
<p>SHEET B2 WOOD NOISE BARRIER ELEVATION - SLOPING GRADE INSTALLATION</p>	
<p>November 2019 _____ DATE</p>	

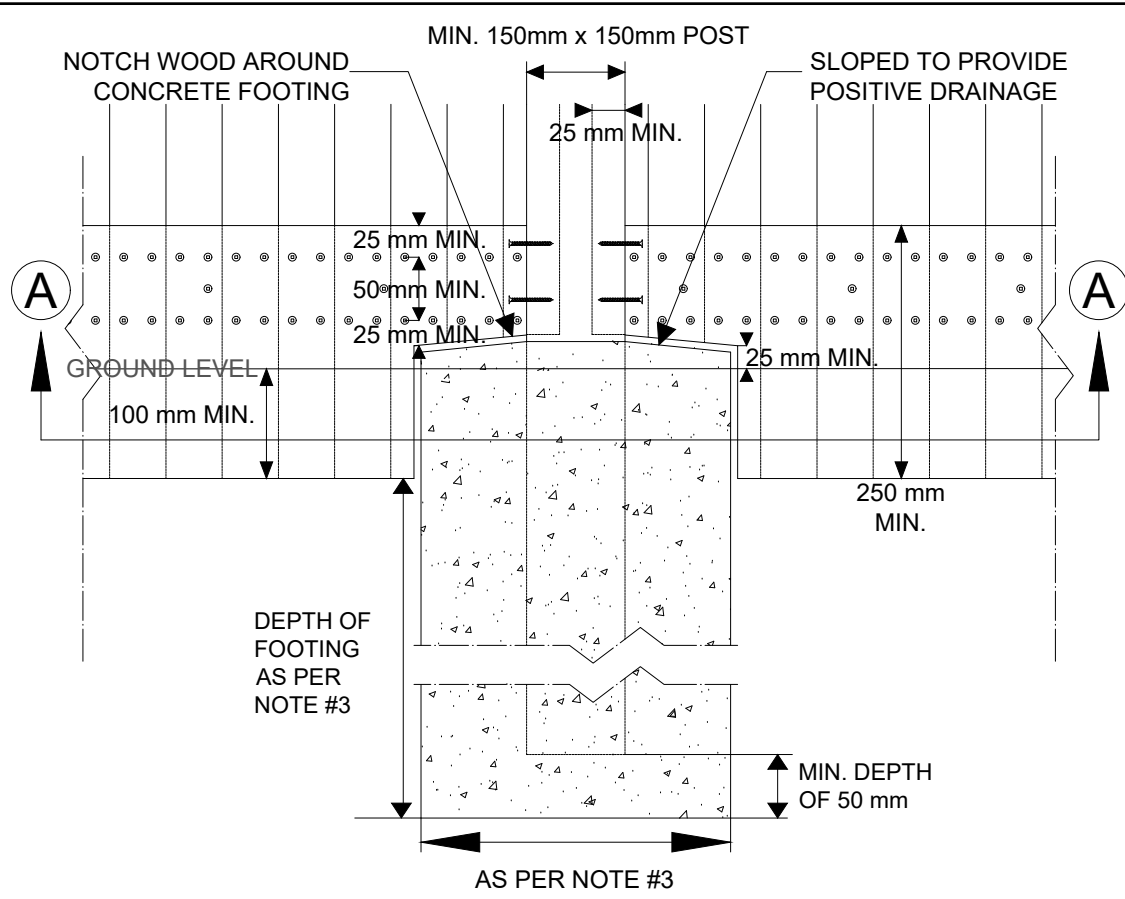

Notes:

1. The pole bases shall be either augered or hand dug if required due to utility constraints.
2. All grassed areas will be reinstated with a minimum of 100 mm good quality imported topsoil and sod.
3. The foundation requirements and the use of Sonotubing shall be designed on a site-specific basis as approved by a Structural Engineer in accordance with the Canadian Highway Bridge Design Code (latest edition). An alternative saddle design system that is made of galvanized steel plate may be considered.
4. All material below finished grade shall be pressure treated or composite material.
5. All earth fill areas to be compacted to 95% maximum dry density or as identified in a soils report if appropriate..
6. All wood to be National Lumber Grading Association. (NLGA)
7. All the footing to be founded on undisturbed soil and minimum below freezing depth.
8. All dimensions in millimetres are nominal sizes. Refer to Sheet G for conversion chart.

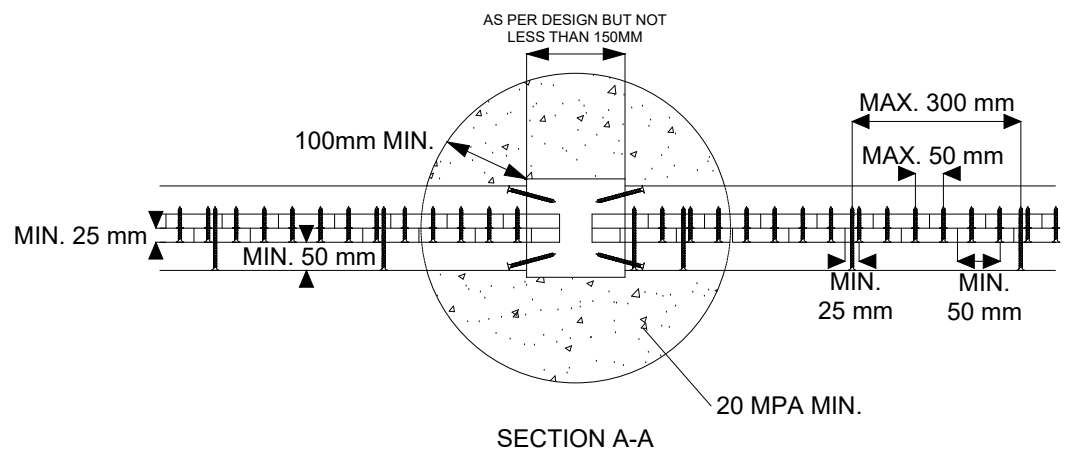

<p>SHEET C</p> <p>POST AND BASE CONSTRUCTION DETAIL</p>
<p>November 2019</p> <p>DATE</p>

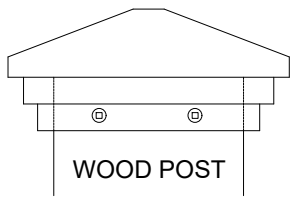

WOOD POST

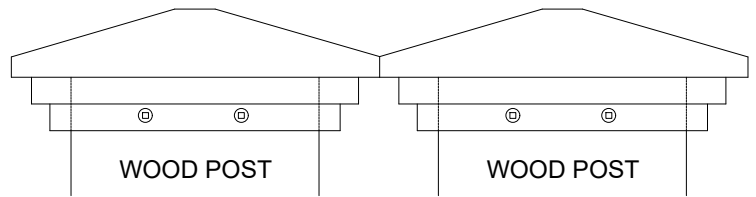

WOOD POST

WOOD POST

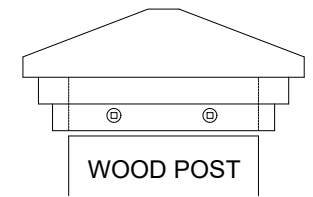

WOOD POST

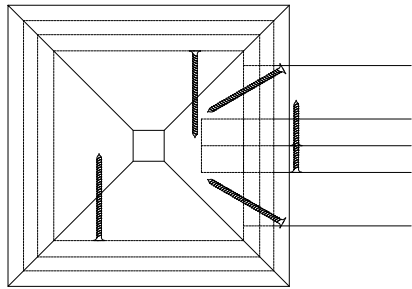

END POST JOINT
AND CAP DETAIL

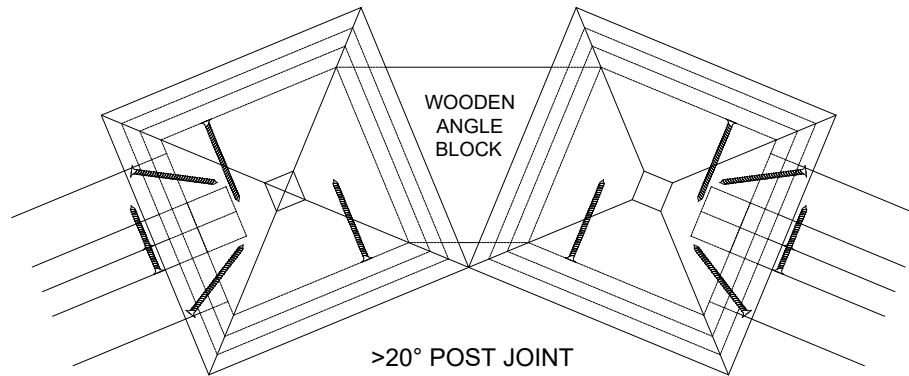

WOODEN
ANGLE
BLOCK

>20° POST JOINT
AND CAP DETAIL

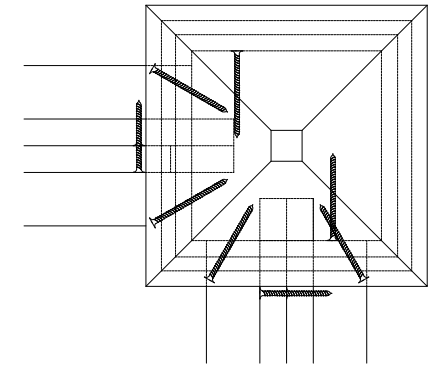

180° POST JOINT
AND CAP DETAIL

Notes:

1. Post Cap materials shall be metal or plastic only and match the finished fence colour and be approved by York Region.
2. All caps shall be fastened with 2 screws or nailed, preferably on opposite sides of the post.
3. Post cap dimensions vary with post size.



**Transportation
Services**

SHEET E
POST & POST CAPPING DETAIL

November 2019

DATE

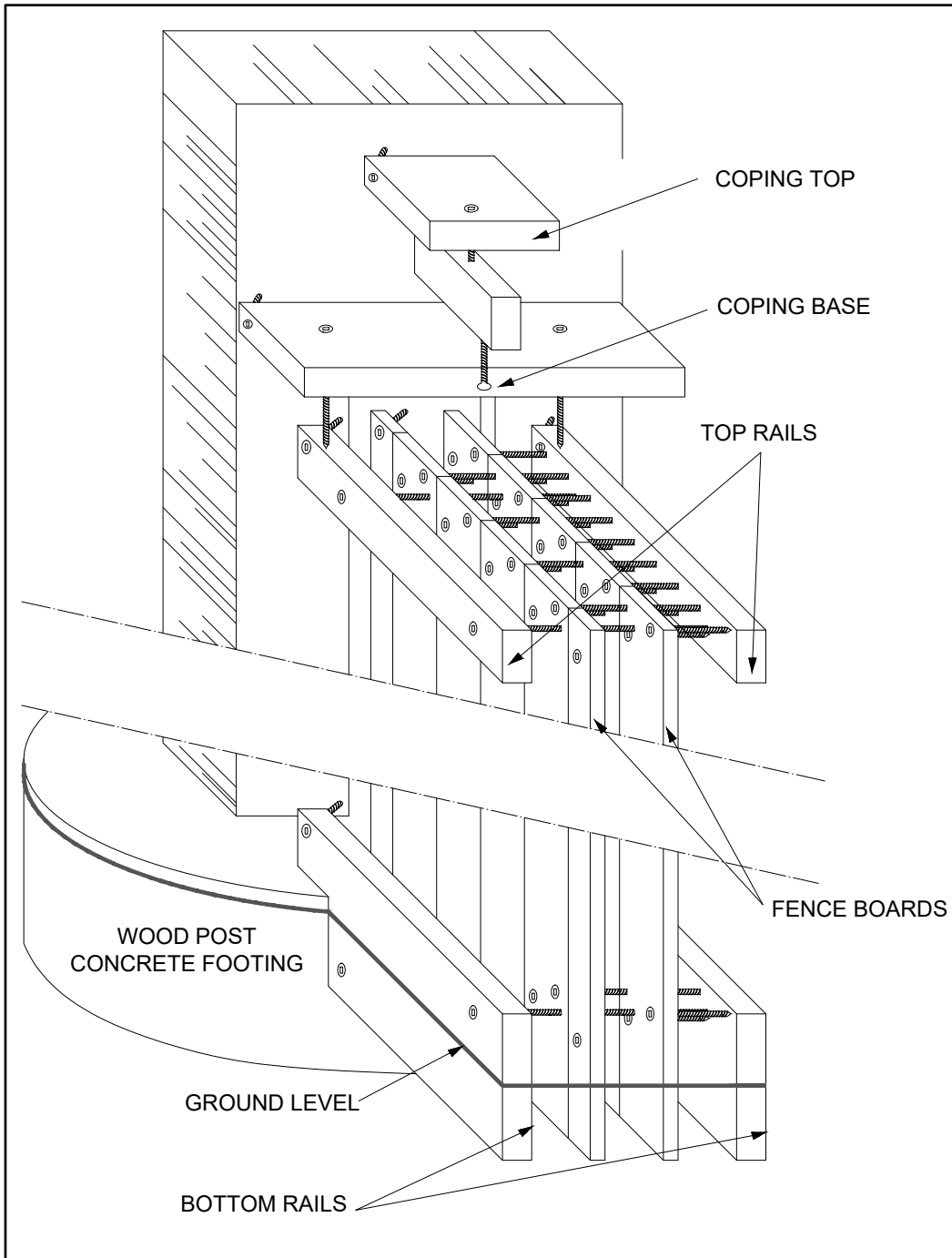

Notes:

1. After setting posts and allowing concrete to cure, the top and bottom rails on the homeowners side of the fence should be fastened.
2. Screw or nail the vertical rails into place starting with the homeowners side rails; each post shall be notched to allow the rails to terminate inside the post. (Refer to Sheet D)
3. Fasten the Region side top and bottom cross members into place.
4. Attach an approved coping feature to the top rails and cap the post.
5. Backfill the area around the bottom rail ensuring to maintain a buried depth of at least 100mm.
6. All fastener lengths to be determined as per Detail "A" on this drawing.

DETAIL A

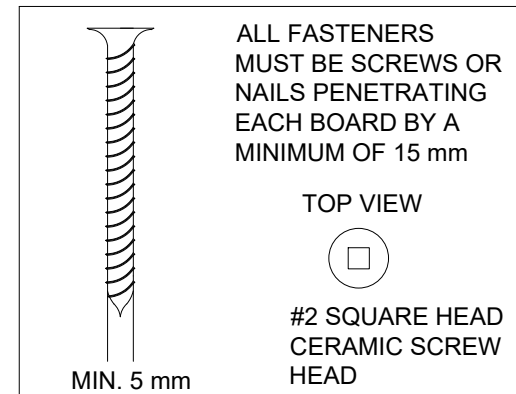

Transportation Services

SHEET F - EXPLODED VIEW
BOARD ON BOARD FASTENING DETAIL

November 2019

DATE

STAIN FOR WOOD FENCE

SHALL CONSIST OF:

- A BASE OF BLENDED RESINS AND OILS IN A WATER SUSPENSION
- SUSPENDED SOLIDS WHICH ARE NOT LESS THAN 21% AND NOT GREATER THAN 31% BY VOLUME
- V.O.C.'S (VOLATILE ORGANIC COMPOUNDS) WHICH ARE NOT IN EXCESS OF 350g/L IN ACCORDANCE WITH A.S.T.M. D-2369
- LEVELS OF LIQUID MICROBICIDES AND ANY OTHER POTENTIAL TOXIC SUBSTANCES WHICH ARE ENVIRONMENTALLY SAFE (NOT REQUIRING PROVINCIAL OR FEDERAL REGISTRATION)
- NONE OF THE FOLLOWING HAZARDOUS SUBSTANCES:
 - FOLPET (N-(TRICHLOROMETHYLTHIO) PHTHALIMIDE)
 - BIS (TRIBUTYL TIN) OXIDE
 - COPPER NAPHTHENATE
 - COPPER 8 QUINOLINOLATE
 - ZINC NAPHTHENATE
- SUFFICIENT OXIDE PIGMENTS TO OBTAIN DESIRED COLOUR TONE AND LEVEL OF OPACITY (COLOUR TO BE APPROVED BY YORK REGION FOR EACH INSTALLATION)

APPLICATION OF STAIN:

APPLY TWO (2) COATS ON CLEAN DRY WOOD USING SPRAY, BRUSH OR DIPPING METHODS TO ACHIEVE FULL COVERAGE OF ALL EXPOSED SURFACES. APPLY OUTDOORS ONLY IN SUITABLE WEATHER CONDITIONS DURING WHICH THE TEMPERATURE IS BETWEEN 5° C AND 21° C FOR A PERIOD OF 48 HOURS FOLLOWING APPLICATION.

DIMENSIONAL LUMBER CONVERSION CHART

NOMINAL (mm)	ACTUAL (mm)	NOMINAL (in.)	ACTUAL (in.)
25	19	1	0.75
50	38	2	1.5
100	89	4	3.5
150	140	6	5.5
200	184	8	7.25
250	235	10	9.25
300	286	12	11.25

MINIMUM WOOD BOARD THICKNESS CHART

TO OBTAIN 20KG/m² SOUND ATTENUATION

SPECIES	ACTUAL WOOD THICKNESS
JACK PINE	2 x 22 mm THICKNESS
RED PINE	2 x 22 mm THICKNESS
PONDEROSA PINE	2 x 22 mm THICKNESS
EASTERN PINE	2 x 22 mm THICKNESS
WESTERN PINE	2 x 25 mm THICKNESS
WESTERN CEDAR	2 x 25 mm THICKNESS
EASTERN CEDAR	2 x 28 mm THICKNESS
NORTHERN WHITE CEDAR	2 x 28 mm THICKNESS
RED SPRUCE	2 x 22 mm THICKNESS
WHITE SPRUCE	2 x 25 mm THICKNESS
SPF	2 x 28 mm THICKNESS



**Transportation
Services**

SHEET G
MATERIAL AND FINISHING DETAIL

November 2019

DATE

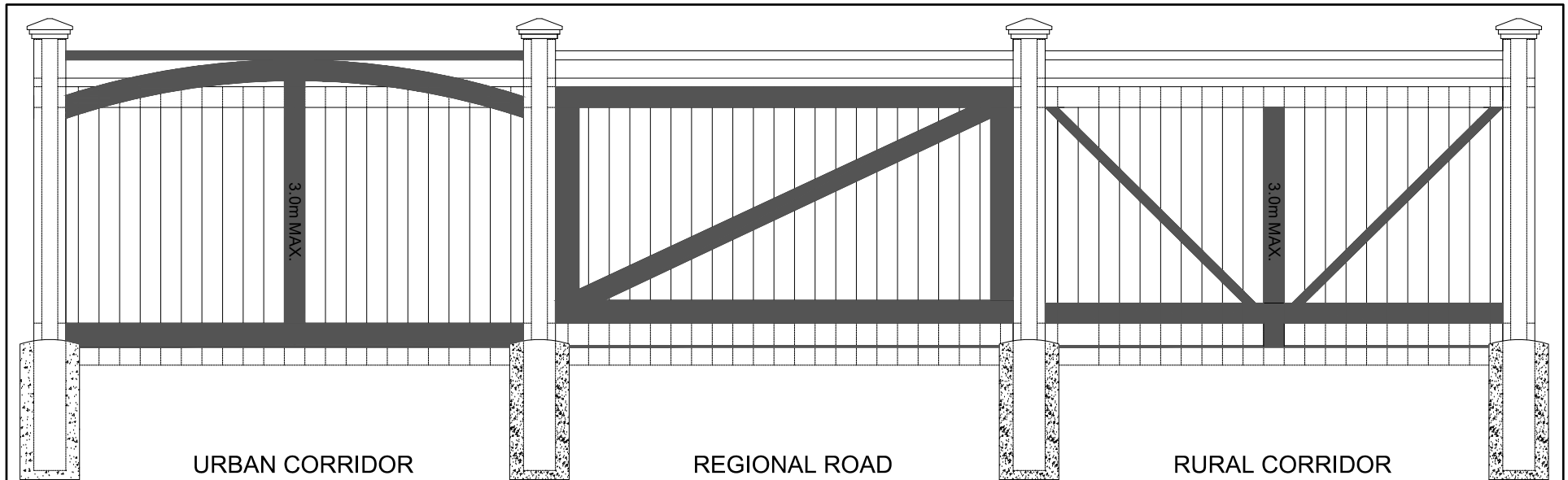

IN ORDER TO MEET PROJECT SPECIFIC GOALS, LANDSCAPING PLANS SHALL BE DEVELOPED AS FOLLOWS:

Where noise attenuation barriers are required, the noise consultant shall be required to retain a licensed landscape architect in order to prepare and develop planting details. The final planting details must be in "tender-ready" landscaping drawings, bill of materials and construction specifications for the purposes of incorporating into a stand alone barrier installation or as part of a road construction project.

Complete "tender-ready" landscape drawings, prepared and stamped by a licensed professional, will be required to be submitted with the drawing submission. Landscape may include hardy perennials, shrub and tree planting and where necessary may include planting on private property where existing landscape material will be impacted by the newly installed barrier.

A site visit with a Regional Staff from York Region's Forestry division and shall be conducted prior to preparing the landscape drawings. Call 1-877-464-9675 to arrange a site meeting and tree species selection.

Drawings will be required to be reviewed and signed off prior to approving the installation of any noise attenuation barrier. The approximate value of the landscape works shall be 3 to 5% of the overall cost of the barrier(s).

Notes:

1. The colours and frequency of application of the treatment is to be approved by York Region Streetscaping Manager.
2. Decorative Masonry Pillars may be considered. For specific treatment type and application, refer to York Region Streetscaping Manager.
3. Regional Centres will require an enhanced treatment suited to an urban design context.



**Transportation
Services**

SHEET H
AESTHETIC ENHANCEMENTS

November 2019

DATE

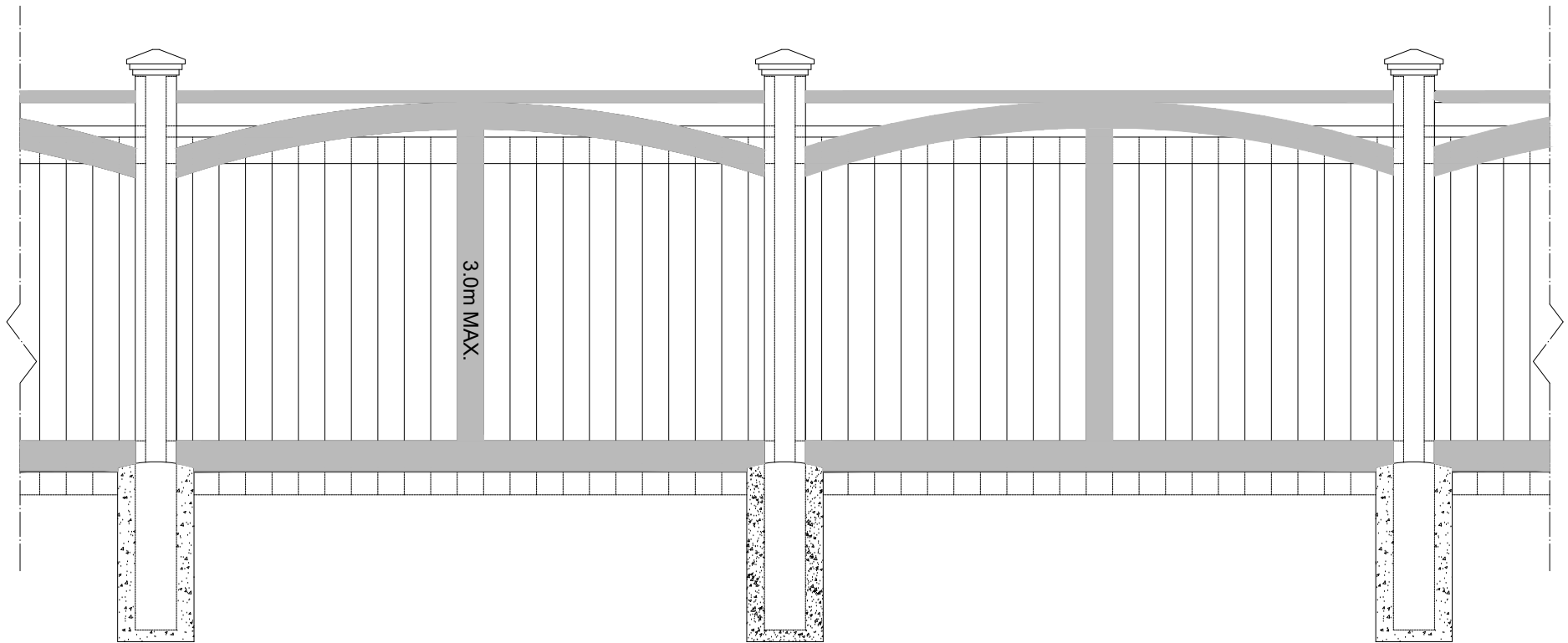

Notes:

1. Refer to Detail Drawings B1 and B2 for construction details.
2. Colour treatments as approved by York Region.



**Transportation
Services**

DETAIL "H 1"
AESTHETIC TREATMENT
APPLICATION: AS APPROVED BY YORK REGION

November 2019

DATE

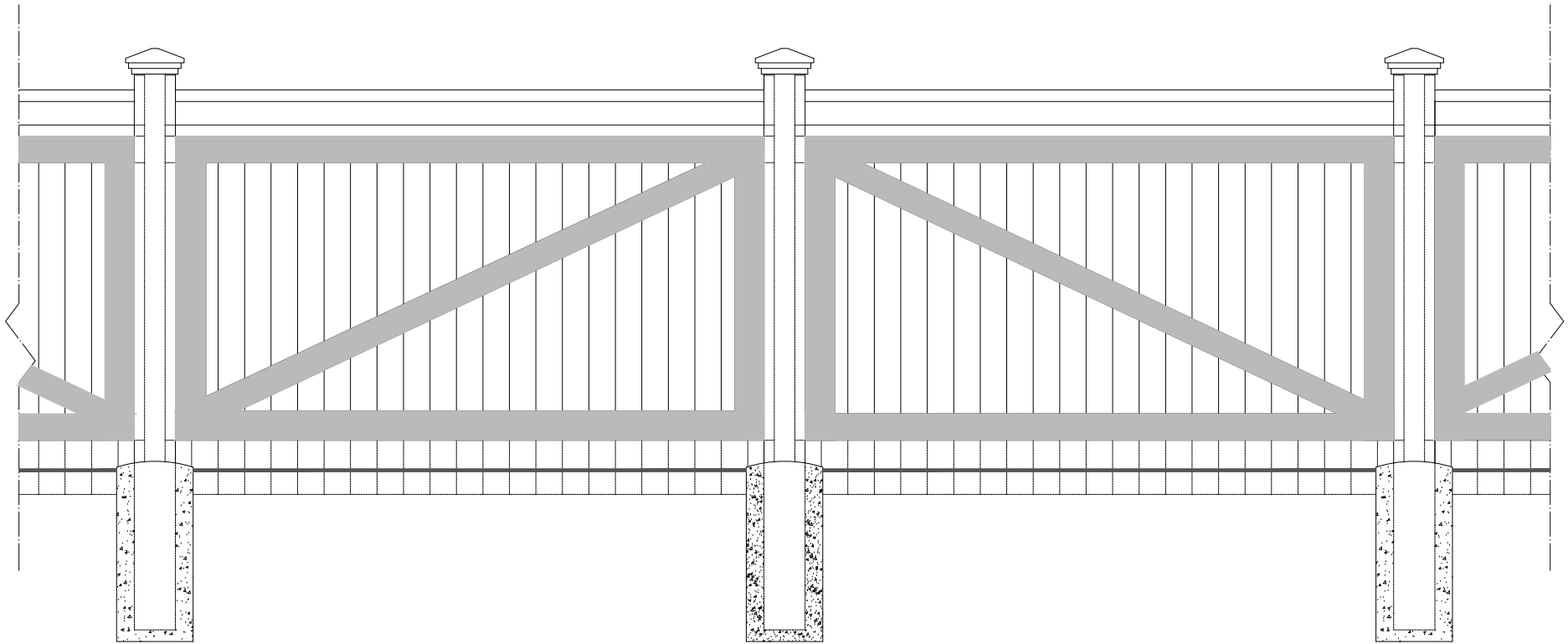

Notes:

1. Refer to Detail Drawings B1 and B2 for construction details.
2. Colour treatments as approved by York Region.



**Transportation
Services**

DETAIL "H 2"
AESTHETIC TREATMENT
APPLICATION: AS APPROVED BY YORK REGION

November 2019

DATE

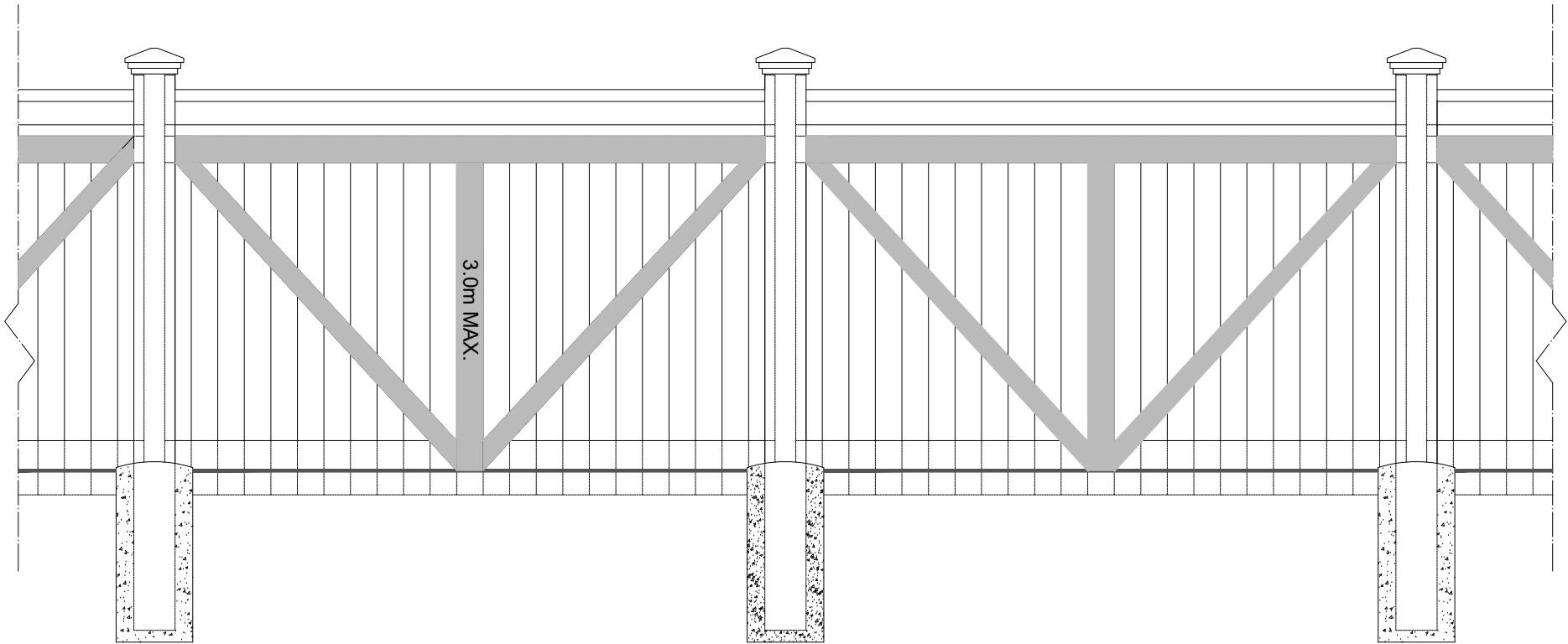

Notes:

1. Refer to Detail Drawings B1 and B2 for construction details.
2. Colour treatments as approved by York Region.



**Transportation
Services**

DETAIL "H 3"
AESTHETIC TREATMENT
APPLICATION: AS APPROVED BY YORK REGION

November 2019

DATE



BURNSIDE

[THE DIFFERENCE IS OUR PEOPLE]

Appendix D

Noise Memorandum – Identification of Points of Reception



Technical Memorandum

Noise Impact Assessment – Phase 1

Identification of Points of Reception

Date: April 1, 2022 **Project No.:** 300052314.0000

Project Name: Warden Avenue and Kennedy Road Environmental Assessment Studies between Major MacKenzie Drive and Elgin Mills Road

Client Name: Regional Municipality of York

Submitted To: Jennifer Vandermeer, P.Eng.

Submitted By: Harvey Watson, P.Eng.

Reviewed By: Kristina Zeromskiene, Ph.D., LEL

R.J. Burnside & Associates Limited has been retained by the Regional Municipality of York to provide a Noise Impact Study in support of the Municipal Class Environmental Assessment (MCEA) Studies for the proposed improvements to Warden Avenue from Major Mackenzie Drive to Elgin Mills Road and Kennedy Road from Major Mackenzie Drive to Elgin Mills Road. The purpose of this memorandum is to provide a methodology required for Phase 1 of the MCEA Studies relating to the Noise Impact Assessment (the Assessment). Specifically, this memorandum establishes the proposed noise receptors that will be evaluated in Phase 3 of the MCEA based on the preliminary preferred road design concepts. The memorandum also defines the noise impact scenarios that are proposed for the Assessment.

Areas sensitive to noise within the Study Areas were identified as part of Phase 1 of the MCEA Studies as well as the locations where noise impacts should be assessed. These locations are outdoor living areas (OLAs) which could potentially be protected by a noise barrier, following the York Region's "Standard Operating Procedures (SOPs) for Traffic Mitigation on Regional Roads" (York Region SOP).

In the Study Areas, Burnside identified 23 OLAs potentially affected by the road expansion of either Warden Avenue or Kennedy Road. These OLAs are listed below.

ID	Address	Receptor Type
Warden Corridor		
OLA01	10726 Warden Avenue	House
OLA02	10565 Warden Avenue	House
OLA03	10506 Warden Avenue	House
OLA04	10050 Warden Avenue	House
OLA11	10620 Warden Avenue	House
OLA12	10508 Warden Avenue	House
OLA13	10348 Warden Avenue	House
OLA14	10206 Warden Avenue	House
OLA15	10148 Warden Avenue	House
OLA17	10084 Warden Avenue	House
OLA16	3 Heritage Hill Drive	House
Kennedy Corridor		
OLA05	4478 Elgin Mills Road East	House
OLA06	4510 Elgin Mills Road East	House
OLA07	10715 Kennedy Road	House
OLA08	10476 Kennedy Road	House
OLA09	10379 Kennedy Road	House
OLA18	10537 Kennedy Road	House
OLA19	10504 Kennedy Road	House
OLA20	10379 Kennedy Road	House
OLA21	10450 Kennedy Road	House
OLA22	10225 Kennedy Road	House
OLA23	10228 Kennedy Road	House
OLA24	10060 Kennedy Road	House

A figure will be provided in the final report showing all OLAs listed above.

Based on a review of the 23 OLAs, the following four OLAs (Selected OLAs) were identified as receptors for noise assessment as they provide a representative subset (approximately one in five homes), thereby providing a characterization of the noise impacts within the Study Areas.

For Warden Avenue this includes:

- 3 Heritage Hill Drive
- 10506 Warden Avenue

For Kennedy Road this includes:

- 10476 Kennedy Road
- 4510 Elgin Mills Road (side lot front on Kennedy Road)

Following the York Region SOP, the Assessment will examine two noise impact scenarios for the four identified receptors. Those scenarios will be:

- Start of Construction Year - the noise impact at the Selected OLAs under the traffic conditions at start of construction (assumes no road improvements are made). This scenario includes the existing noise barrier.
- Mature State of Development - the noise impact at the Selected OLAs under future traffic conditions at mature state of development with road improvements made. This scenario includes the existing noise barrier.

The traffic speed statistics used for the assessment will include the 50th percentile, 85th percentile and volume weighted speeds.

Based on the comparison of noise levels for the Start of Construction and Mature State of Development, if the change in noise levels at the Selected OLAs increases by 5 dB or greater or the total noise impact from road traffic is 60 dBA or greater, Burnside will select the next closest OLA to the exceedance location(s) and analyze those new location(s) until the point is reached where there is no exceedance. Burnside will then take the list of receptors where exceedances are occurring and apply the specific conditions noted in Appendix A of the SOP to determine if mitigation is administratively feasible. If feasible, Burnside will further assess if making changes to the existing noise barrier at 3 Heritage Hill Drive (i.e., increasing height to a maximum of 3 m) or constructing a new noise barrier (to a maximum of 3 m) at other location(s) will result in a minimum 6 dB reduction in noise level per the York Region SOP.

R.J. Burnside & Associates Limited



Harvey Watson, P.Eng.
Manager, Air & Noise
HW:lam

Other than by the addressee, copying or distribution of this document, in whole or in part, is not permitted without the express written consent of R.J. Burnside & Associates Limited.

